

YLAA0189SE-YLAA0485SE YLAA0195HE-YLAA0515HE
YLAE0195SE-YLAE0490SE YLAE0195HE-YLAA0510HE YLAE0195LT-YLAE0490LT
YCWL0240SE - YCWL0395SE YCWL/YCRL0200HE - YCWL/YCRL0610HE

OPERATING INSTRUCTION

Revision 1

Form 201.26.OI1(11/09)

(035-21976-110)

AIR & WATER COOLED LIQUID CHILLERS MICRO BASED CONTROL SYSTEM WITH IPUII

SOFTWARE VERSION C.MMC.16.03 AND HIGHER
SE - STANDARD EFFICIENCY, HE - HIGH EFFICIENCY
LT - LOW TEMPERATURE

Tempo & Zafiro

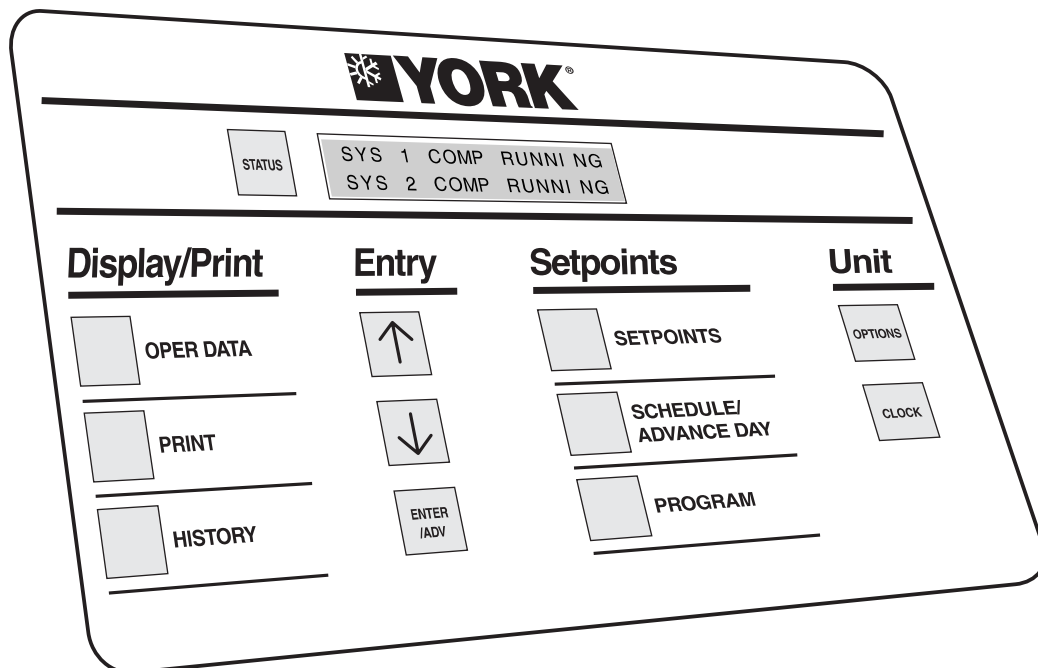

R410A



TABLE OF CONTENTS

1 GENERAL		6 ENTRY KEYS	
1.1 Control Panel	1.1	6.1 UP ARROW and DOWN ARROW Keys	1.26
1.1.1 AMB (IPU II and I/O Boards)	1.1	6.2 ENTER/ADV Key	1.26
1.1.2 Internal Clock & Memory Backup Battery	1.1	7 SETPOINTS KEYS	
1.1.3 Keypad and Display	1.2	7.1 Cooling Setpoints	1.26
1.1.4 Unit (Chiller) ON/OFF Switch	1.2	7.2 SCHEDULE/ADVANCE DAY Key	1.27
1.1.5 Customer Controls	1.2	7.3 PROGRAM Key	1.28
1.1.6 Remote Start/Stop	1.2	7.4 Setpoint and Cut-out Settings	1.30
1.1.7 Flow Switch	1.2	8 UNIT KEYS	
1.1.8 EMS PWM Remote Setpoint Reset	1.2	8.1 OPTIONS Key	1.31
1.1.9 Load Limiting	1.4	8.2 CLOCK Key	1.33
1.1.10 Fan Full Speed Inhibit (110 V circuit) YLAE Units with Dual Speed Fans only	1.4	9 OPTIONAL SOFT START	
1.1.11 Fan Full Speed Inhibit (30VDC Circuit) YLAA Units with Dual Speed Fans only	1.4	9.1 Diagnostics	1.34
1.1.12 Chilled Liquid Pump Control	1.4	10 INPUTS / OUTPUTS	
1.1.13 Alarms	1.4	10.1 Digital Inputs	1.35
1.1.14 System Run Status	1.4	10.2 Analogue Inputs	1.35
2 Operation		10.3 Digital Outputs	1.36
2.1 Capacity Control	1.5	10.4 Analogue Output	1.36
2.2 Anti-Recycle Timer	1.7	11 OPTIONAL PRINTER INSTALLATION	
2.3 Anti-Coincidence Timer	1.7	11.1 Installation Limitations	1.37
2.4 Compressor Crankcase Heater	1.7	11.2 Parts	1.37
2.5 Pumpdown (YLLSV) Control	1.7	11.3 Assembly and Wiring	1.37
2.6 Evaporator Solenoid Valve (YESV) Control	1.7	11.4 Using Other Printers	1.37
2.6.1 YLAA Low Ambient Unit	1.7	11.5 Warranty	1.37
2.7 Lead/Lag Control	1.8	11.6 Obtaining a Printout	1.37
2.8 Condenser Coil Fan Control	1.8	12 BAS/EMS TEMPERATURE RESET USING A VOLTAGE OR CURRENT SIGNAL	
2.8.1 Single speed fans	1.11	12.1 0-10 Vdc Remote Signal	1.38
2.8.2 YLAA and YLAE 2 Speed Fan Option	1.12	12.2 2-10 Vdc Remote Signal	1.38
2.8.3 Fan Star/Delta Dwell Time	1.13	12.3 0-20 mA Remote Signal	1.38
3 Control Panel Keys		12.4 4-20 mA Remote Signal	1.38
4 Status Key		12.5 EMS-PWM Remote Temperature Reset	1.39
4.1 General Status Messages	1.15	13 ISN CONTROL (York Talk -AMB Terminal Block TB1)	
4.2 Fault Status Messages	1.17	13.1 Received Data (Control Data)	1.39
5 Display/Print Keys		13.2 Transmitted Data	1.40
5.1 OPER DATA Key	1.19		
5.2 PRINT Key	1.22		
5.3 History Key	1.24		
5.3.1 Clearing History Buffers	1.24		
5.3.2 History Messages	1.24		
5.3.3 Software Version	1.25		

**14 BACnet and Modbus
(-AMB Board Terminal Block TB1)**

14.1 BACnet and Modbus Data Communication 1.41

15 HEATPUMP OPTION

15.1 Heatpump Mode Selection 1.45

15.2 OPER DATA Key 1.45

15.3 SETPOINTS Key 1.45

15.4 Leaving Liquid Temperature Control 1.45

15.5 BAS/EMS Temperature Reset - Voltage /
Current Signal 1.46

15.5.1 0-10 Vdc Remote Signal 1.46

15.5.2 2-10 Vdc Remote Signal 1.46

15.5.3 0-20 mA Remote Signal 1.46

15.5.4 4-20 mA Remote Signal 1.47

15.6 EMS-PWM Remote Temperature Reset 1.47

1 GENERAL

The units are designed to work independently, or in conjunction with other equipment via ISN, Bacnet or Modbus building management systems or other automated control systems. When operating, the unit controls monitor the chilled liquid system temperatures at the unit and take the appropriate action to maintain the temperatures within desired limits. This action will involve running one or more compressors to match the cooling effect of the refrigerating systems to the heat load on the liquid system. The heat removed from the chilled liquid is then rejected to the air or water cooled condenser.

1.1 Control Panel

A microprocessor based control system is fitted to the units. It is capable of dual refrigerant system (circuit) control to maintain chilled liquid temperature within programmed limits, as well as sequencing, system safeties, displaying status, and daily schedules.

Remote cycling, demand limiting and chilled liquid temperature reset can be accomplished by field supplied contacts.

Compressor starting/stopping and loading/unloading decisions are performed by the microprocessor to maintain leaving liquid temperature. These decisions are a function of temperature deviation from 'SETPOINT'.

A master (UNIT) ON/OFF switch is provided on the chiller control panel to activate or deactivate the complete chiller.

On YLAA and YLAE units with the optional Hydro kit the control of the single or duty/standby pumps are integral to the control system.

1.1.1 AMB (IPU II and I/O Boards)

The IPU and I/O boards are assembled to function as a single microprocessor controller. The IPU II board contains a 'Coldfire' microprocessor and is the controller and decision maker in the control panel. The I/O board handles all of the unit I/O (Inputs and Outputs). System inputs from pressure transducers and temperature sensors are connected to the I/O board.

The I/O board contains a processor capable of reading the inputs and controlling the outputs. It communicates through the transition header with the IPU II microprocessor. The I/O board circuitry multiplexes the analog inputs, digitizes them, and constantly scans them to keep watch on the unit operating conditions. The input values are transmitted serially to the IPU II microprocessor board.

From this information, the IPU II then issues commands to the I/O board relay outputs to control contactors, solenoids, etc. for Leaving Liquid Temperature Control and to react to safety conditions. The I/O board converts logic signals to operate relay outputs to 115 VAC levels used by motor contactors, solenoid valves, etc. to control system operation. The low voltage side of all relay coils on the I/O board are powered by +12V.

Keypad commands are actuated upon by the microprocessor to change setpoints, cutouts, scheduling, operating requirements, and to provide displays. The keypad and display are connected to the I/O board.

The on-board power supply converts 24 Vac from T1 (120/24 VAC transformer), to +12 Vdc, +5 Vdc and +3.3 Vdc using switching and linear voltage regulators located on the I/O and IPU II boards. These voltages are used to operate integrated circuitry on the board. The power supply for the 40 Character Display and unit sensors (transducers and temperature sensors) is also derived from the +5 V. supply. The 24 Vac is also rectified, but not regulated, to provide unregulated +30 Vdc to supply all of the digital inputs.

The IPU II board contains one green 'Power' LED to indicate that the board is powered up and one red 'Status' LED (flashing) to indicate that the processor is operating.

The I/O board contains one green 'Power' LED to indicate that the board is powered up and one red 'Status' LED (flashing) to indicate that the processor is operating. The I/O board also contains two sets of Receiver/Transmit LED's, one for each available serial communication port. The receive LED's are green, and the Transmit LED's are red.

A jumper on the I/O board selects 20 mA or 10 Vdc as the input type on the remote temperature reset analog input.

1.1.2 Internal Clock & Memory Backup Battery

The AMB board contains a real time clock (RTC) integrated circuit chip with an internal battery backup. The battery backup assures that any programmed values (setpoints, clock, cut-outs, etc.) are not lost during a power failure or shutdown period regardless of the time involved.

1.1.3 Keypad and Display

User interface is via a touch keypad and a liquid crystal display allowing access to operating and programmed data. Information can be displayed in S.I. (Metric) or Imperial units. The 40 character liquid crystal display (2 lines of 20 characters) is used for displaying system parameters and operator messages. The display has a lighted background for night viewing as well as a special feature which intensifies the display for viewing in direct sunlight.

1.1.4 Unit (Chiller) ON/OFF Switch

The unit ON/OFF switch is located just below the keypad. This switch allows the operator to turn the entire chiller OFF, if desired. The switch must be placed in the ON position for the chiller to operate. Any time the switch is in the OFF position, a STATUS message will be displayed.

1.1.5 Customer Controls

The microprocessor based control system can accept remote signals to start and stop the chiller, to adjust the leaving liquid temperature setpoint and to load limit the unit. To reduce unit noise on YLAA and YLAE units with the 2 speed fan option, a customer voltage free contact can be connected to inhibit fan full speed. These functions can easily be controlled by connecting user supplied voltage free contacts to the customer terminals in the electronics section of the control panel.

In addition, run status and alarm contacts are provided to remotely signal system status and faults.

SYSTEM INPUTS



Wiring from remote voltage free contacts should be run in screened cable earthed at the panel end only. If an inductive device (relay, contactor) is supplying these contacts, the coil of the device must be suppressed with a standard RC suppresser across the inductive coil.

1.1.6 Remote Start/Stop

Remote start/stop can be accomplished using a time clock, manual contact or other voltage free contact connected to terminals 13 and 14 (-ARB circuit board on YLAA and YLAE units) or 13 and 51 (-XTBC1 on YCWL/YCRL units). The contact must be closed to allow the chiller to run. Any time the contact opens for more than 3 seconds, the chiller will shutdown and the 'REMOTE STOP NO RUN PERM' message will be displayed.

1.1.7 Flow Switch (YCWL/YCRL and YLAA / YLAE units without the hydro kit option)

The customer must install and wire a field mounted flow switch. The flow switch should be rated for 30 Vdc 1 to 3 ma, gold contacts recommended, connected to terminals 13 and 18 (-ARB circuit board on YLAA and YLAE units) and 13 and 14 (-XTBC1 on YCWL/YCRL units) to provide adequate protection against loss of liquid flow.



The flow switch should never be by-passed. This will cause damage to the chiller and invalidate the warranty.

The optional Hydro Kit is fitted with a flow switch.

1.1.8 EMS PWM Remote Setpoint Reset (Activated on request)

The leaving liquid temperature setpoint programmed into the microprocessor can be remotely adjusted to a higher value using repeated timed closure of voltage free contacts 13 and 20 (-ARB circuit board on YLAA and YLAE units) and 13 and 20 (-XTBC1 on YCWL/YCRL units). The duration of the contact closure will decide the amount of adjustment.

For noise immunity, the microprocessor will ignore closures of less than 1 second.

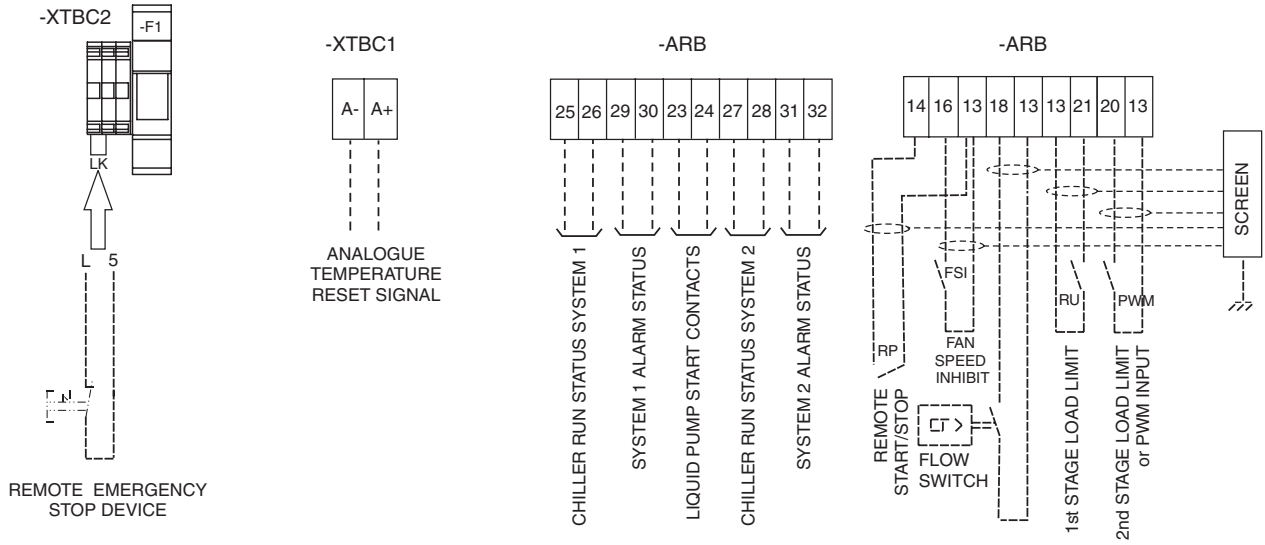

YLAA Customer Controls

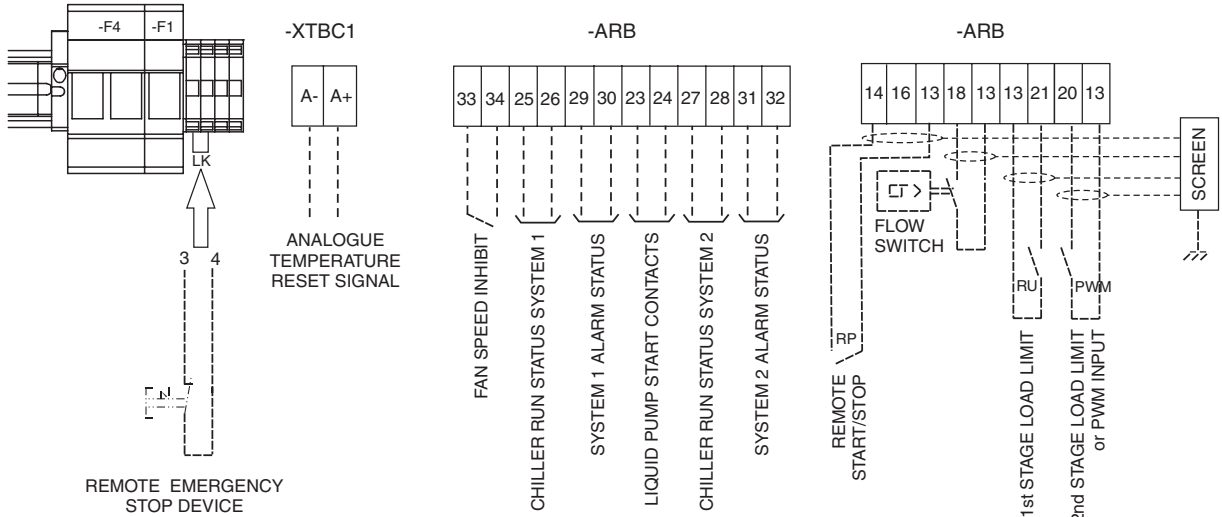

YLAE Customer Controls

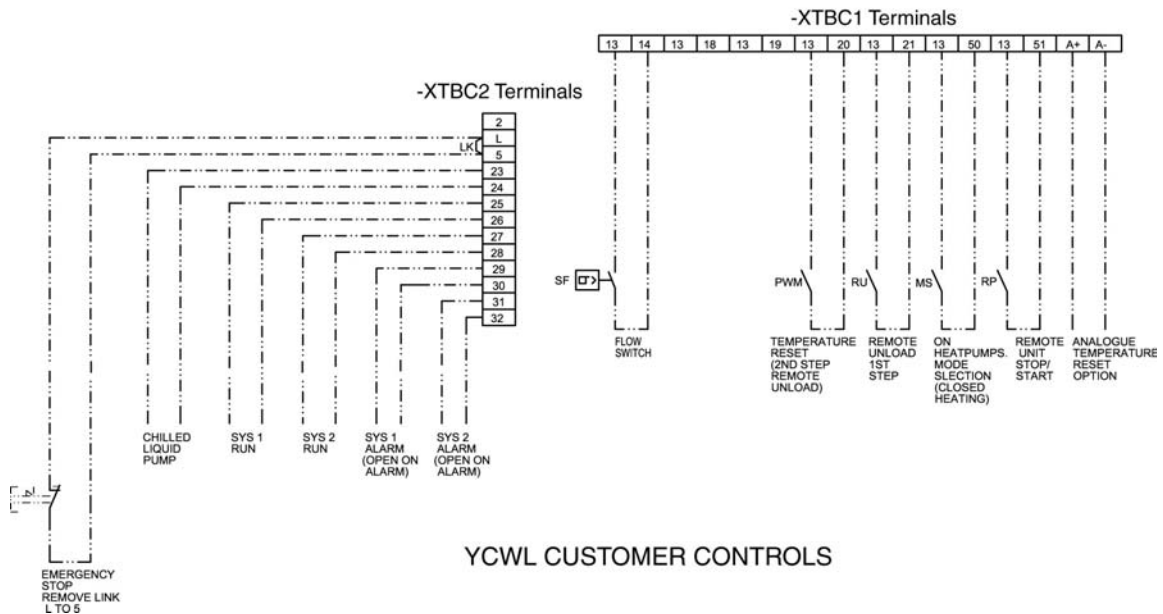

YCWL CUSTOMER CONTROLS

1.1.9 Load Limiting

Load Limiting prevents the unit from loading beyond a desired value. 4 compressor units can be load limited to 50% of the compressors by allowing only 1 compressor per system to run. 5 compressor units can be load limited to 40% or 80% of the compressors. The 80% would allow a up 2 compressors per system to run and the 40% limit would allow up to 1 compressor per system to run. 6 compressor units can be load limited to 33% or 66% of the compressors. The 66% limit would allow up to 2 compressors per system to run, and the 33% limit would allow up to 1 compressor per system to run. No other values of limiting are available.

The unit can be load limited through remote communication via an ISN, Bacnet or Modbus, or through closing contacts connected to the Load Limit terminals 13 and 21 and PWM inputs terminals 13-20. (-ARB circuit board on YLAA and YLAE units, -XTBC1 on YCWL/YCRL units). Stage 1 of load limiting involves closing the Load Limit input. Stage 2 of load limiting involves closing both the Load Limit and PWM inputs. The first stage of limiting is either 50% of unit on 4 compressor units, 80% on 5 compressor units or 66.3% on 6 compressor units. The second stage of limiting is only available on 5 and 6 compressor units, 40% of unit on 5 compressor units or 33% on 6 compressor units. Remote unload when using remote contacts is available when either REMOTE or LOCAL is selected for LOCAL / REMOTE MODE under the OPTION key.

Simultaneous operation of Load Limiting and EMS-PWM Temperature Reset is not possible. However Load Limiting when using remote unload contacts can be implemented if the analog temperature reset is used.

**1.1.10 Fan Full Speed Inhibit (110 V circuit)
YLAE Units with Dual Speed Fans only**

To reduce unit noise the fans can be limited to run at a maximum step of all fans in star (reduced speed) i.e. fan full speed is inhibited. Connect a customer voltage free contact to terminals 33 & 34 (-ARB circuit board).

The contact must be rated for 110 Vac, connecting wiring does not need to be run in screened cable. When the contact is closed fan full speed inhibit is in effect.

**1.1.11 Fan Full Speed Inhibit (30VDC Circuit)
YLAA Units with Dual Speed Fans only**

To reduce unit noise the fans can be limited to run at a maximum step of all fans in star (reduced speed) i.e. fan full speed is inhibited. Connect a customer voltage free contact to terminals 13 & 16 (-ARB circuit board). When the contact is closed fan full speed inhibit is in effect.

VOLTAGE FREE CONTACTS

A 28 Vdc or up to 254 Vac external circuit (supplied by others) may be connected to these contacts. The contacts are rated at 125 VA.



If any inductive load device (relay or contactor) is connected to these contacts, the device must be suppressed at the load with a RC suppressor across the inductive coil. Failure to install suppressors will result in nuisance faults and possible damage to the unit.

**1.1.12 Chilled Liquid Pump Control
(YCWL/YCRL and YLAA / YLAE units without the hydro kit option)**

Terminals 23 and 24 (-ARB circuit board on YLAA and YLAE units) and 23 and 24 (-XTBC1 on YCWL/YCRL units) close to start the liquid pump. After the "30 second stop to start timer" has timed out, this contact is closed if there is a 'Leaving Liquid Temperature Cutout', any of the compressors are running, or, the daily schedule is not calling for a shutdown with the unit switch 'ON' and the remote stop/start input closed, terminals 13 and 14 (-ARB circuit board on YLAA and YLAE units) and 13 and 51 (-XTBC1 on YCWL/YCRL units).



The contact must be used to ensure that the pump is running in the event of a 'Leaving Liquid Temperature Cutout'.

The pump contact will not close to run the pump if the unit has been powered up for less than 30 seconds, or if the pump has run in the last 30 seconds, to prevent pump motor overheating.

1.1.13 Alarms

Contacts are provided on -ARB circuit board on YLAA and YLAE units and -XTBC2 on YCWL/YCRL units, which can be used to remotely signal alarms. The contacts are normally open (N.O.) and will close when control power is applied to the panel, if no fault conditions are present. When a fault occurs which locks out a system or the unit power is lost, the contacts open. To obtain a system alarm signal, connect the alarm circuit to terminals 29 and 30 for No. 1 system and terminals 31 and 32 for No. 2 system.

1.1.14 System Run Status

System run status is indicated by closure of contacts on -ARB circuit board on YLAA and YLAE units and -XTBC2 on YCWL/YCRL units, terminals 25 and 26 for system 1 and terminals 27 and 28 for system 2.

2 Operation

The operating sequence described below relates to operation on a cooling demand start after power has been applied, such as start-up commissioning.

When power is applied to the unit a 2 minute timer will start. This timer also prevents instantaneous starting after a power failure if the option POWER FAILURE RESTART is set to AUTOMATIC under the OPTION key.

If the option POWER FAILURE RESTART is set to MANUAL under the OPTION key the unit switch must be set to OFF then back to ON to reset the unit lockout condition UNIT FAULT: 115VAC UNDER VOLTAGE.

For a unit to run, the unit switch and the software system switches under the option key must be set to on, any remote cycling contacts must be closed, the 'Daily Schedule' must be scheduling the unit on, and a temperature demand must be present. The status message will read 'FLOW SWITCH OPEN' for 30 seconds after which a contact closes to start the evaporator pump. On the closing of the flow switch the remaining time on the 120 second anti-recycle timers will be displayed.

At the end of the 2 minute timer, the microprocessor will check for cooling demand. If all conditions allow for a start, the first compressor on the lead system will start and the liquid line solenoid will open. Coincident with the start, the anti-coincident timer will be set and begin counting downward from '60' seconds to '0' seconds.

If the unit is programmed for 'Automatic Lead/Lag Control', the system with the shortest average run-time of the compressors will be assigned as the 'lead' system. A new lead/lag assignment is made whenever all systems shut down.

After 1 minute of compressor run time, the next compressor in sequence will start when a system has to load. Additional compressors will be started at 60 second intervals as needed to satisfy temperature load.

If demand requires, the lag system will come on with the same timing sequences as the lead system. However the lead system must be running for a minimum of 5 minutes before the lag system will be allowed to run.

As the load decreases below the 'SETPOINT', the compressors will be shut down in sequence. This will occur at intervals of either 30, 15 or 10 seconds based on the liquid temperature as compared to 'SETPOINT', and control mode.

When the last compressor in each system is to be cycled off, the system will initiate a pump-down. On a non-safety, non-unit switch shutdown, the YLLSV will be turned off, and the last compressor will be allowed to run until the suction pressure falls below the suction pressure cut-out or for 180 seconds, which ever comes first.

2.1 Capacity Control

The control system will evaluate the need for cooling by comparing the actual leaving chilled liquid temperature to the desired 'SETPOINT', and regulate the leaving chilled liquid temperature to meet that desired 'SETPOINT'.

The leaving chilled liquid 'SETPOINT' is the temperature the unit will control to within +/- the 'RANGE'. The Setpoint High Limit is the 'SETPOINT' plus the 'RANGE'. The Setpoint Low Limit is the 'SETPOINT' minus the 'RANGE'.

The 'RANGE' setting takes into account the number of compressors on the unit and the temperature difference between leaving (LCHLT) and return (RCHLT) chilled liquid at full load (refer to Section 7.1 for details).

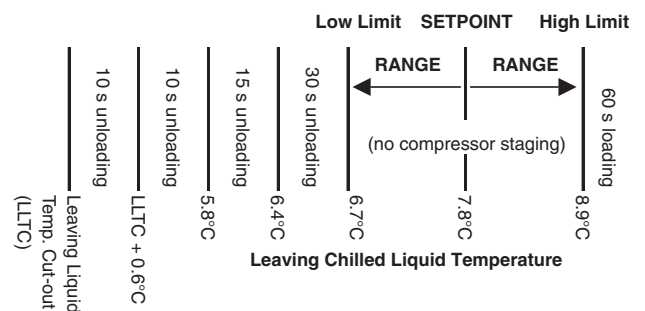

Each system has its own anti-recycle timers. The anti-recycle time under the PROGRAM key can be programmed between 240 and 600 seconds and sets the minimum start-to-start time of the lead compressor in a system. Due to lead lag rotation in a system, consecutive lead compressor starts are not with the same compressor. A second non-programmable anti-recycle timer, stop to start is fixed at 90 seconds, starts to countdown when the lead compressor in a systems cycles off.

The lag compressors in a system, are not controlled by the anti-recycle timer. They have no start to start timer other than the effect of system lead/lag rotation and the load/unload timers. For a given compressor this gives a minimum start to start time of 140 seconds on systems with 2 compressors or 210 seconds on systems with 3 compressors. Their minimum stop to start time for a given compressor is 60 seconds, the 60 second load timer.

When the leaving chilled liquid temperature is above the Setpoint High Limit, the lead compressor on the lead system will be energised along with the liquid line solenoid.

After 60 seconds of run-time if the leaving chilled liquid temperature is still above the Setpoint High Limit and the leaving chilled liquid temperature is not falling faster than the programmed RATE SENSITIVITY within the programmed RATE CONTROL TEMPERATURE RANGE or above the RATE CONTROL TEMPERATURE RANGE at 1.7°C per minute, the next compressor in sequence will be energised.

Additional loading stages are energised at a rate of one every 60 seconds if the chilled liquid temperature remains above the Setpoint High Limit and the same criteria on leaving chilled liquid temperature rate of change as above are met.

The strategy for loading/unloading is design to meet the following criteria:

1. Minimise system starting and stopping;
2. The lag system is not available to start until the lead system cannot load further and has been running for 5 minutes;
3. When both systems are running, balance loading / unloading between them.

With both systems running the next system to load is determined by the following rules;

1. The system must not be fully loaded or pumping down;
2. Remote load limit, suction limiting or discharge limiting must not be in effect on the system.

If both systems are available to load the system with the lowest number of compressors running will load. If both systems have the same number of compressors running the lead system will load.

On units without soft start the strategy for compressor loading within a system is to maximize individual compressor run time and ensure that the same compressor does not start twice in a row. This is achieved by rotating the lead/lag sequence of the compressors in a system when a compressor other than the lag most compressor in that system stops. In achieving this objective no attempt will be made to equalize each compressors individual total run hours within a system.

On units with soft start the compressor in each system with soft start is always the last to start. Compressors are always started in the same order, No1 compressor first.

If the chilled liquid temperature falls below the Setpoint High Limit but is greater than the Setpoint Low Limit, loading and unloading do not occur. This area of control is called the 'CONTROL RANGE'.

If the chilled liquid temperature drops to less than 0.28°C below the Setpoint Low Limit, unloading occurs at a rate of 30 seconds. If the chilled liquid temperature falls to a value greater than 0.28°C below the Setpoint Low Limit but not greater than 0.83°C below the Setpoint Low Limit, unloading occurs at a rate of 15 seconds. If the chilled liquid temperature falls to a value greater than 0.83°C below the Setpoint Low Limit, unloading occurs at a rate of 10 seconds. If the leaving chilled liquid temperature falls to 0.6 °C above the leaving liquid temperature cutout, unloading occurs at a rate of 10 seconds.

If more than one compressor is running in a system then on unloading the compressor to be stopped is not the same compressor stopped during the last unload sequence. This is achieved by rotating the lead lag sequence of the compressors in a system when a compressor in that system stops.

The leaving chilled liquid 'SETPOINT' is programmable from 4.4°C to 21.1°C in the chilled liquid water mode and from -7°C to 21.1°C in chilled liquid glycol mode. In both modes, the 'RANGE' can be from +/-0.8°C to 1.4°C. A low temperature glycol unit is available which will go down to -13°C.

To ensure that the Setpoint Low Limit cannot be inadvertently set to low when setting the Setpoint and Control Range in the water cooling mode the software makes the following adjustments. If as a result of Setpoint and Control Range setting the Setpoint Low Limit would be below 4.4°C the software will set the Setpoint Low Limit to 4.4°C and raise the Setpoint High Limit by the difference to maintain the same Control Range.

To ensure reliable operation of the unit the software will modify the operation of the 'Leaving Chilled Liquid Control' as follows:

1. If the run time of the lead system is less than 5 minutes the Setpoint High Limit is increased up to a maximum of 10°C by the 'Setpoint Adjust Value' shown in the following graph. Any adjustment value in excess of the value taking the Setpoint High Limit to 10°C is taken from the Setpoint Low Limit. When the run time exceeds 5 minutes the 'Setpoint Adjust Value' returns to zero. This will occur whilst the unit is running. Pressing the 'COOLING SETPOINTS' key four times will display the lead system's last run time and the 'Setpoint Adjust Value'.
2. If the run time of the lead system is less than 5 minutes on 3 successive occasions, the anti-recycle timer will be doubled, with a maximum allowable anti-recycle value of 10 minutes.

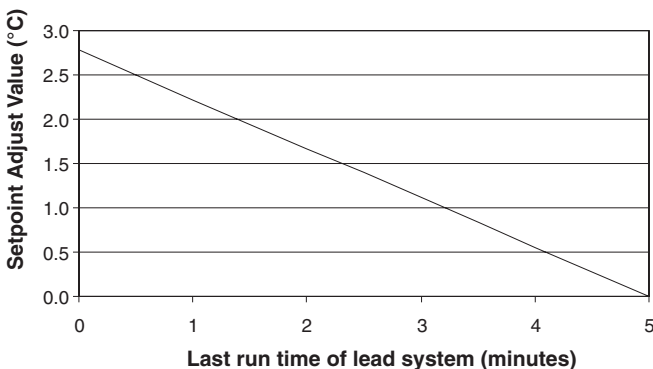

2.2 Anti-Recycle Timer

Each system has its own anti-recycle timers. The anti-recycle time under the PROGRAM key can be programmed between 240 - 600 seconds and sets the minimum start-to-start time of the lead compressor in a system. A second non-programmable anti-recycle timer, stop to start is fixed at 90 seconds, starts to countdown when the lead compressor in a systems cycles off. On power up only this timer is set to 120 seconds not 90 seconds.

The lag compressor(s) in a system, are not controlled by the anti-recycle timer

2.3 Anti-Coincidence Timer

The anti-coincidence timer prevents both systems from starting simultaneously. This assures that the inrush current is kept to a minimum. A 60 second time delay will always separate motor starts. This timer is not programmable.

2.4 Compressor Crankcase Heater

Each compressor is fitted with a crankcase heater (not controlled by the micro processor) which is ON when the compressor is OFF.

2.5 Pumpdown (YLLSV) Control

Each system has a pumpdown feature at shut-off. On a non-safety, non-unit switch shutdown, all compressors but one in the system will be shut off. The liquid line solenoid (YLLSV) will also be turned off. The final compressor will be allowed to run until the suction pressure falls below the cut-out or for 180 seconds, which ever comes first. Systems can be manually pumped down, using the system switches under the 'OPTIONS' key.

2.6 Evaporator Solenoid Valve (YESV) Control

YLAA Units only. System 1 on models 220HE, 240SE & 260HE, System 2 on models 240SE,260HE, 285 & 300HE.

The valve is always closed when the system is not running. The valve is open by timer KT for the first 300 seconds of system operation. This prevents low suction pressure problems on system start. On low ambient units a solenoid valve is fitted on each system, but the timer KT is only fitted and operated as described on the models and systems above. On low ambient units this solenoid valve opens when the system is running provided the ambient temperature is below 4.4°C. The valve will close when the ambient temperature rises above 7.2°C provided KT is not fitted and acting to open the valve.

2.6.1 YLAA Low Ambient Unit

Low Ambient Kit

Each system on all low ambient units is fitted with an Evaporator Solenoid Valve (YESV) which operates as describe above. On systems with less than 4 fans a fan speed controller is fitted to fan No1. Fan contactor KF1 is wired to energize when the system starts and the speed of the fan is controlled according to discharge pressure. The remaining fans are controlled as normal. A heater is also fitted to the power element on the TXV as part of the low ambient kit. The heater is on when the ambient temperature is below 4.4°C. The heater is off when the ambient rise to above 7.2°C

2.7 Lead/Lag Control

The chiller may be set up for AUTO or MANUAL lead/lag. This is accomplished by programming the option under the 'OPTIONS' key.

When AUTO lead/lag is used, the microprocessor attempts to balance run time between the systems. A number of conditions can occur which will prevent this from happening. Factors determining lead/lag selection and the resulting lead/lag determination are:

The microprocessor automatically defaults the lead to system 1 and the lag to system 2 if both systems are ready to start (Anti-recycle Timers timed out) and the systems have equal run time.

If both systems are waiting to start (Anti-recycle timers have not timed out), the microprocessor will assign the lead to the system with the shortest anti-recycle time to provide cooling quickly.

If the lead system is locked out, faulted and waiting to restart the lag system is swapped to the lead.

MANUAL lead/Lag selection will be automatically overridden by the microprocessor to allow the lag system to automatically become the lead anytime the selected lead system shuts down due to, lead system faults.

Automatic switch over in MANUAL mode is provided to try to maintain chilled liquid temperature as close to 'SETPOINT' as possible.

2.8 Condenser Coil Fan Control
(YLAA & YLAE Units)

The fans are controlled by the discharge pressure. There are two to four steps of fan discharge pressure control plus step time control dependant on the number of fans in a system. Subsequent to the compressor starting, and if required by the discharge pressure, there will be a time delay of 5 seconds before the first fan can start. The delay between turning on and off fan stages is fixed at 5 seconds. The controller increments or decrements the fan stage by one stage at a time based on the discharge pressure and the fan delay time. The number of stages required is determined by the discharge pressure. The number of fans in each system is given in the table below.

YLAA MODEL	SYSTEM 1	SYSTEM 2
0180SE to 320SE 0195HE to 0260HE	2	2
0360SE, 0400SE 0300HE	3	2
0390HE	4	2
0435SE, 0485SE 0350HE	3	3
0440HE	4	3
0455HE, 0515HE	4	4
YLAE MODEL	SYSTEM 1	SYSTEM 2
0190SE to 330SE 0195HE to 0265HE	2	2
0315HE	3	2
0375SE to 0490SE 0355HE to 0405HE	3	3
0465HE to 0510HE	4	4

Low Ambient Units

On systems with 2 or 3 fans, fan number 1 is replaced by a variable speed fan. On system 2 of YLAA180SE, 195HE and 210SE the two small fans are replaced by one variable speed fan. The fan is not controlled by the discharge pressure stages but is energized directly from the fan fuses when the unit power is turned on. The fan motor has a integral inverter which controls fan speed to maintain a pressure between 18 and 22.5 barg. Below 18 barg the fan should be off, above 22.5 barg the fan should be at full speed, with a linear response between these two pressures. A separate 4-20ma pressure transducer (-BFDP) is wired via a relay (-KF1) to the fan. The relay energizes along with the liquid line solenoid to connect the pressure transducer to the fan. When the system is off, the transducer is disconnected and the fan will stop. When the system is running the transducer is connected to the fan and thus fan speed is based on discharge pressure. The fan motor inverter has integrated EMC filtering. The fan motor will restart automatically after any of the following trips - Line failure - Phase Failure - Line under Voltage - DC link voltage too high or too low - Locked rotor. For trips on high motor or motor electronics temperatures the fan motor will not automatically reset. The 3 phase power to the fan motor must be disconnected for at least one minute. If any system is still running the system should be shutdown on the system switches under the option key. The unit disconnect switch must be open for one minute to allow the fan electronics to reset.



DANGER OF ELECTRICAL SHOCK. The unit disconnect switch must be opened for a minimum of 5 minutes before the panel power section or fan motor terminal cover is opened to allow the the variable speed fans internal power supply to decay to a safe level.

YLAA Fan Configuration

On low ambient units fans =2-MF1 and =2-MF2 are replaced by a single fan =2-MF1

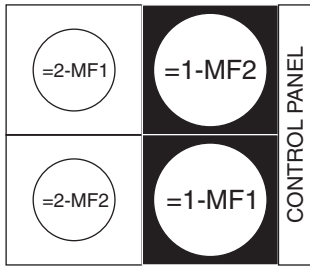

YLAA 180SE, 195HE, 210SE

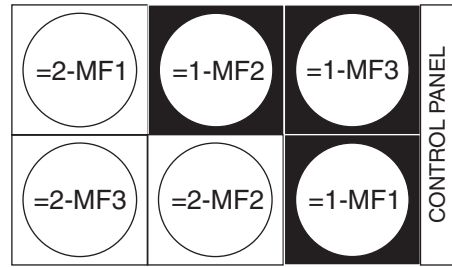

YLAA 350HE, 435SE, 485SE

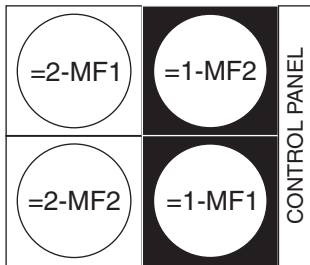

YLAA 220HE, 240SE, 260HE, 285SE, 320SE

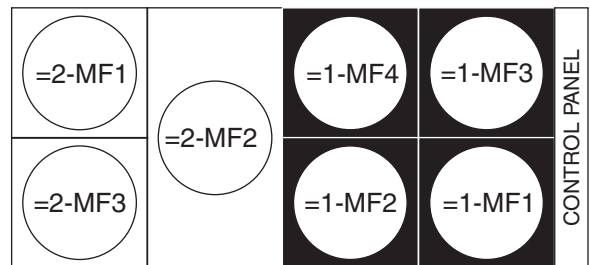

YLAA 440HE

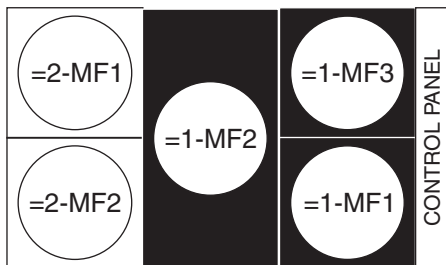

YLAA 300HE, 360SE, 400SE

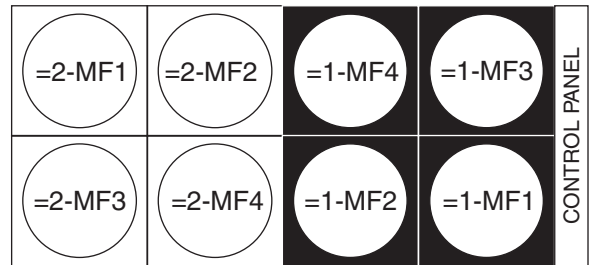

YLAA 455HE, 515HE

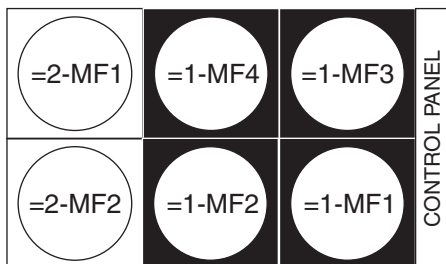

YLAA 390HE

YLAE Fan Configuration

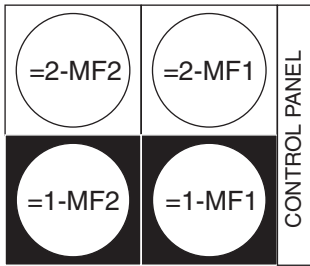

YLAE 0190SE to 0330SE,
YLAE 0195HE to 0265HE

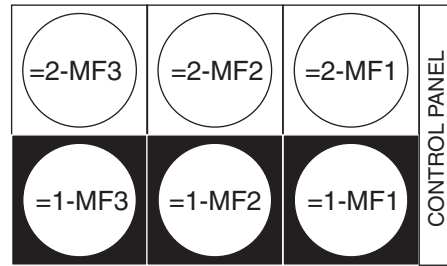

YLAE 0375SE to 0490SE,
YLAE 0355HE to 0405HE

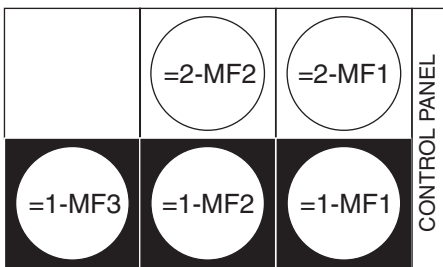

YLAE 0315HE

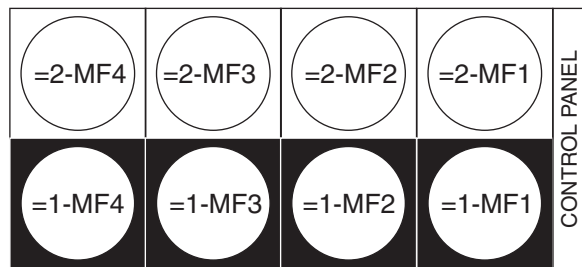

YLAE 0465HE to 0510HE

2.8.1 Single speed fans

The Fan On Pressure is programmable under the PROGRAM key. When the discharge pressure is > Fan On Pressure and the fan delay timer has expired, the fan stage is incremented by 1. After incrementing the fan stage the fan delay timer is set to 5 seconds and the Fan On Pressure is ramped from 1.4 BARG over the original value back to the original value over the next 20 seconds.

The Fan Off Pressure is equal to the Fan On Pressure minus the Fan Diff Off Pressure which is programmable under the PROGRAM key. When the discharge pressure is < Fan Off Pressure and the fan delay timer has expired, the fan stage is decremented by 1. After decrementing the fan stage the fan delay timer is set to 5 seconds and the Fan Off Pressure is ramped from 1.4 BARG below the original value back to the original value over the next 20 seconds

The following tables show the relationship between fan stages and the microprocessor digital outputs and fans:

Systems with 2 fans

STAGES	FAN OUTPUTS 1 1-MF1, 2-MF1 =AMB-XTB7-8 (SYS1) =AMB-XTB10-8 (SYS2)	FAN OUTPUTS 2 1-MF2, 2-MF2 =AMB-XTB7-9 (SYS1) =AMB-XTB10-9 (SYS2)
0	OFF	OFF
1	ON	OFF
2	ON	ON

Systems with 3 fans

STAGES	FAN OUTPUTS 1 1-MF1, 2-MF1 =AMB-XTB7-8 (SYS1) =AMB-XTB10-8 (SYS2)	FAN OUTPUTS 2 1-MF2, 2-MF2 =AMB-XTB7-9 (SYS1) =AMB-XTB10-9 (SYS2)	FAN OUTPUTS 3 1-MF3, 2-MF3 =AMB-XTB7-10 (SYS1) =AMB-XTB10-10 (SYS2)
0	OFF	OFF	OFF
1	ON	OFF	OFF
2	ON	ON	OFF
3	ON	ON	ON

Systems with 4 fans

STAGES	FAN OUTPUTS 1 1-MF1, 2-MF1 =AMB-XTB7-8 (SYS1) =AMB-XTB10-8 (SYS2)	FAN OUTPUTS 2 1-MF2, 2-MF2 =AMB-XTB7-9 (SYS1) =AMB-XTB10-9 (SYS2)	FAN OUTPUTS 3 1-MF3 & 1-MF4, 2-MF3 & 2-MF4 =AMB-XTB7-10 (SYS1) =AMB-XTB10-10 (SYS2)
0	OFF	OFF	OFF
1	ON	OFF	OFF
2	ON	ON	OFF
3	ON	OFF	ON
4	ON	ON	ON

2.8.2 YLAA and YLAE 2 Speed Fan Option

The reason for two speed fans is to reduce unit noise by running the fans in slow speed over as wide a range of conditions as possible, only going to full speed as a last resort. This is achieved by raising the pressure at which the last fan stage occurs, switching from all fans running in slow speed to all fans running in fast speed.

The Fan On Pressure is programmable under the PROGRAM key. When the discharge pressure is > Fan On Pressure and the fan delay timer has expired, the fan stage is incremented by 1. After incrementing the fan stage the fan delay timer is set to 5 seconds and the Fan On Pressure is ramped from 1.4 BARG over the original value back to the original value over the next 20 seconds. On a fan stage incrementing so that the next incremented fan stage would result in the fans switching from slow to fast speed, the fan delay timer is set to 5 seconds and the Fan On Pressure is raised by 5.5 BARG. The Fan OFF Pressure is not move at this time. If the discharge pressure then rise above this new value and the fan delay timer has expired, the fan stage is incremented by 1. The fan delay timer is set to 5 seconds and the Fan OFF Pressure is raised by 5.5 BARG. All fans on full speed.

On a fan stage decrements resulting in the fans switching from fast to slow speed, the fan delay timer is set to 5 seconds and the Fan OFF Pressure is lowered by 5.5 BARG back to the programmed Fan OFF Pressure. No further lowering or ramping back up, occurs when this stage decrements. All fans now running on slow speed. The Fan Off Pressure is equal to

the Fan On Pressure minus the Fan Diff Off Pressure which is programmable under the PROGRAM key.

On a further fall in discharge pressure when the discharge pressure is < Fan Off Pressure and the fan delay timer has expired, the fan stage is decremented by 1. After decrementing the fan stage the fan delay timer is set to 5 seconds and the Fan Off Pressure is ramped from 1.4 BARG below the original value back to the original value over the next 20 seconds.

The following tables show the relationship between fan stages and the microprocessor digital outputs and fans .

2.8.3 Fan Star/Delta Dwell Time

YLAA Units

In incrementing to the last fan stage all the fan motors are reconnected from star (slow speed) to delta (fast speed). Similarly when decrementing from the last fan stage all the fan motors are reconnected from delta (fast speed) to star (slow speed). To ensure that arcing on the contactors are cleared on switching between states the following step are enacted.

1. Turn off all fan Line contactors.
2. Wait 500ms.
3. Change the state of KS relay and hence all of the low speed (Star) KFL contactors and high speed (delta) KFH contactors.

YLAA Systems with 3 fans

STAGES	Fan Operation			
	FAN OUTPUTS 1 1-MF1, 2-MF1 =AMB-XTB7-8 (SYS1) =AMB-XTB10-8 (SYS2)	FAN OUTPUTS 2 1-MF2, 2-MF2 =AMB-XTB7-9 (SYS1) =AMB-XTB10-9 (SYS2)	FAN OUTPUTS 3 1-MF3, 2-MF3 =AMB-XTB7-10 (SYS1) =AMB-XTB10-10 (SYS2)	SLOW/HIGH SPEED 1-KFS, 2-KFS =AMB-XTB8-5 (SYS1) =AMB-XTB8-8/9 (SYS2)
0	OFF	OFF	OFF	OFF
1	SLOW	OFF	OFF	OFF
2	SLOW	SLOW	OFF	OFF
3	SLOW	SLOW	SLOW	OFF
4	FAST	FAST	FAST	ON

YLAA Systems with 4 fans

STAGES	Fan Operation			
	FAN OUTPUTS 1 1-MF1, 2-MF1 =AMB-XTB7-8 (SYS1) =AMB-XTB10-8 (SYS2)	FAN OUTPUTS 2 1-MF2, 2-MF2 =AMB-XTB7-9 (SYS1) =AMB-XTB10-9 (SYS2)	FAN OUTPUTS 3 1-MF3, 2-MF3 1-MF4, 2-MF4 =AMB-XTB7-10 (SYS1) =AMB-XTB10-10 (SYS2)	SLOW/HIGH SPEED 1-KFS, 2-KFS =AMB-XTB8-5 (SYS1) =AMB-XTB8-8/9 (SYS2)
0	OFF	OFF	OFF	OFF
1	SLOW	OFF	OFF	OFF
2	SLOW	SLOW	OFF	OFF
3	SLOW	OFF	SLOW	OFF
4	SLOW	SLOW	SLOW	OFF
5	FAST	FAST	FAST	ON

YLAE Fan Stages

STAGES	FAN OUTPUTS 1 =AMB-XTB7-8 (YLAE SYS1) =AMB-XTB10-8 (YLAE SYS2)	FAN OUTPUTS 2 =AMB-XTB7-9 (YLAE SYS1) =AMB-XTB10-9 (YLAE SYS2)	FAN OUTPUTS 3 =AMB-XTB7-10 (YLAE SYS1) =AMB-XTB10-10 (YLAE SYS2)
0	OFF	OFF	OFF
1	ON	OFF	OFF
2*	OFF	ON	OFF
3	ON	ON	OFF
4	ON	ON	ON

*Stage 2 is skipped on systems with 2 fans.

YLAE Systems with 2 fans

Stages	Fan Operation	
	1-MF1 2-MF1	1-MF2 2-MF2
0	OFF	OFF
1	SLOW	OFF
3	SLOW	SLOW
4	FAST	FAST

Systems with 3 fans

Stages	Fan Operation	
	1-MF1 2-MF1	1-MF2 & 1-MF3 2-MF2 & 2-MF3
0	OFF	OFF
1	SLOW	OFF
2	OFF	SLOW
3	SLOW	SLOW
4	FAST	FAST

Systems with 4 fans

Stages	Fan Operation		
	1-MF1 2-MF1	1-MF2 & 1-MF3 2-MF2 & 2-MF3	1-MF4 2-MF4
0	OFF	OFF	OFF
1	SLOW	OFF	OFF
2	OFF	SLOW	OFF
3	SLOW	SLOW	SLOW
4	FAST	FAST	FAST

4. Wait 500ms

5. Turn on all the fan line contactors, each fan stage output, 100ms apart.

Fan Speed Inhibit

Fans all running on slow speed is the maximum fan stage when:

- The remote fan full speed inhibit contact is closed.
- If a fan inhibit time period is set under the 'SCHEDULE/ADVANCE DAY' key, and the time of day is in the 'INHIBIT ON' zone.

YLAE Units

When changing from fan stage 3 to fan stage 4 all the fan motors are reconnected from star (slow speed) to delta (full speed). Similarly when reverting from fan stage 4 to fan stage 3 all the fan motors are reconnected from delta (full speed) to star (slow speed). To ensure that arcing on the contactors are cleared on switching between states the following dwell times are set:

TIME	1	2	3
STAGE 3	ON	ON	OFF
0 (Transition start)	OFF	OFF	OFF
500 ms	OFF	OFF	ON
1000 ms (Transition complete)	ON	ON	ON
STAGE 4	ON	ON	ON

The transition from stage 4 to 3 requires the following sequence based on time:

TIME	FAN OUTPUT		
	1	2	3
STAGE 4	ON	ON	ON
0 (Transition start)	OFF	OFF	OFF
1000 ms (Transition complete)	ON	ON	OFF
STAGE 3	ON	ON	OFF

Fan Speed Inhibit

Stage 3 is the maximum fan stage when:

- the remote fan full speed inhibit contact is closed.
- if a fan inhibit time period is set under the 'SCHEDULE/ADVANCE DAY' key, and the time of day is in the 'INHIBIT ON' zone.

Units without Soft Start

The strategy for compressor loading within a system is to maximize individual compressor run time and ensure that the same compressor does not start twice in a row. This is achieved by rotating the lead/lag sequence of the compressors in a system when a compressor other than the lag most compressor in that system stops. In achieving this objective no attempt will be made to equalize each compressors individual total run hours within a system.

Units with Soft Start

These units have a soft starter fitted to the last compressor in each system. SOFT START ENABLED must be displayed under the 'OPTIONS' key. With this option enabled the controls ensure that the compressor fitted with the soft starter is the last compressor to start in the system. Compressors are always started in the same order, No1 compressor first.

3 Control Panel Keys

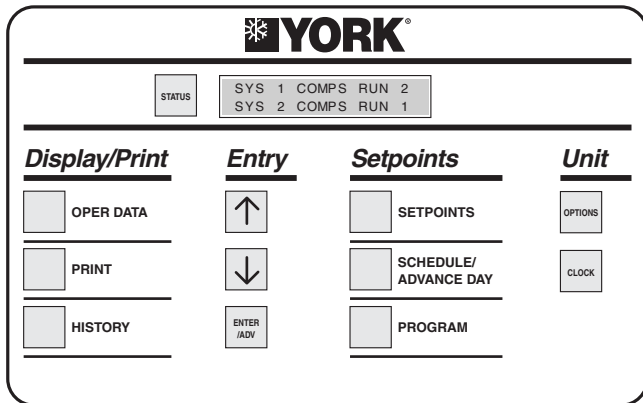

Status Key - (refer to Section 4)

This key provides a display of the current operational and/or fault status of the chiller or individual refrigerant systems.

Display/Print Keys - (refer to Section 5)

These keys allow control panel display or remote printout of both current real-time operating data as well as fault history data from recent safety shutdowns.

Entry Keys - (refer to Section 6)

These keys are used for entering data required for programming the chiller. The keys are also used for scrolling through displays.

Setpoints Keys - (refer to Section 7)

These keys are used for display and programming: the local and remote chilled liquid temperature setpoints; the operating schedule for the chiller; the chiller operational settings and limits.

Unit Keys - (refer to Section 8)

These keys allow the unit options and clock to be set.

4 Status Key

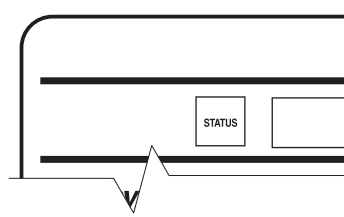

Pressing the 'STATUS' key displays the unit operating status. The messages displayed will include running status, cooling demand, fault status, external cycling device status, load limiting and anti-recycle/coincident timer status. The display will be a single message relating to the highest priority message as determined by the microprocessor. Status messages fall into the categories of General Status and Fault Status.

The following messages can be displayed when the 'Status' key is pressed. In the case of messages which apply to individual systems, system 1 and system 2 messages will both be displayed and may be different. Following each message is an explanation of its meaning:

4.1 General Status Messages

UNIT SWITCH OFF
SHUTDOWN

The unit 'ON/OFF' switch on the control panel is in the 'OFF' position which will not allow the unit to run.

REMOTE CONTROLLED
SHUTDOWN

An Integrated Systems Network (ISN) or Building Automation System (BAS) has turned the unit off.

DAILY SCHEDULE
SHUTDOWN

The 'DAILY/HOLIDAY SCHEDULE' programmed is keeping the unit from running.

REMOTE STOP
NO RUN PERMISSIVE

A remote start/stop contact, terminals 13 and 14 (-ARB circuit board on YLAA and YLAE units) and 13 and 51 (-XTBC1 on YCWL/YCRL units), is open and the unit will not run.

FLOW SWITCH
NO RUN PERMISSIVE

The flow switch, terminals 13 and 18 (-ARB circuit board on YLAA and YLAE units) and 13 and 14 (-XTBC1 on

YCWL/YCRL units), is open and the unit will not run or if running, pumpdown and stop. A pumpdown and stop due to the flow switch opening is recorded in history as a UNIT FAULT: FLOW SWITCH OPEN, but no remote alarm is given.

```
S Y S   1   S Y S   S W I T C H   O F F
S Y S   2   S Y S   S W I T C H   O F F
```

The system switch under 'OPTIONS' is turned off. The system will not be allowed to run until the switch is turned back on.

```
S Y S   1   N O   C O O L   L O A D
S Y S   2   N O   C O O L   L O A D
```

The chilled liquid temperature is below the point (determined by the 'SETPOINT' and 'RANGE') that the microprocessor will bring on a system or that the microprocessor has not loaded the lead system far enough into the loading sequence to be ready to bring the lag system on. The lag system will display this message until the loading sequence is ready for the lag system to start.

```
S Y S   1   C O M P S   R U N   X
S Y S   2   C O M P S   R U N   X
```

Indicates that the respective system is running due to demand. The 'X' will be replaced with the number of compressors in that system that are running.

```
S Y S   1   A R   T I M E R   X X   S
S Y S   2   A R   T I M E R   X X   S
```

Shows the amount of time left on the respective systems anti-recycle timer. This message is displayed when the system is unable to start due the anti-recycle timer being active.

```
S Y S   1   A C   T I M E R   X X   S
S Y S   2   A C   T I M E R   X X   S
```

The anti-coincident timer is a software feature that guards against 2 systems starting simultaneously. This assures instantaneous starting current does not become excessively high due to simultaneous starts. The microprocessor limits the time between compressor starts to 1 minute regardless of demand or the anti-recycle timer being timed out.

```
S Y S   1   D S C H   L I M I T I N G
S Y S   2   D S C H   L I M I T I N G
```

Discharge pressure limiting is in effect. The limiting pressure is a factory set limit to keep the system from faulting on the high discharge pressure cutout due to high load or pull down conditions. When the unload point

is reached, the microprocessor will automatically unload the affected system by de-energising one compressor.

The discharge pressure unload will occur when the discharge pressure gets within 0.7 barg of the programmed discharge pressure cutout. This will only happen if the system is fully loaded and will shut only one compressor off. Discharge limiting will prevent the last compressor in a system from starting if the discharge pressure is above 85% of the programmed discharge pressure cutout. Reloading the affected system will occur when the discharge pressure drops to 85% of the unload pressure and 10 minutes have elapsed.

```
S Y S   1   S U C T   L I M I T I N G
S Y S   2   S U C T   L I M I T I N G
```

Suction pressure limiting is in effect. The suction pressure limit is a control point that limits the loading of a system when the suction pressure drops to within 15% above the suction pressure cutout. On a standard system programmed for 6.0 bar suction pressure cutout, the microprocessor would inhibit loading of the affected system with the suction pressure less than or equal to 1.15 * 6.0 bar = 6.9 bar. The system will be allowed to load after 60 seconds and after the suction pressure rises above the suction pressure limit point.



Suction pressure limiting will not unload a system. Suction pressure limiting only prevents further loading.

```
S Y S   1   L O A D   L I M I T   X X %
S Y S   2   L O A D   L I M I T   X X %
```

Load limiting is in effect at the percentage shown. This limiting could be due to a load limit/PWM input (-ARB circuit board on YLAA and YLAE units or -XTBC1 on YCWL/YCRL units) or an ISN, Bacnet or Modbus load limit command.

```
M A N U A L
O V E R R I D E
```

'MANUAL OVERRIDE' mode is selected under the 'OPTIONS' key. In this mode the 'Daily Schedule' is ignored and the chiller will start-up when chilled liquid temperature allows and the flow switch/remote contacts, unit switch and system switches permit. This is a priority message and cannot be overridden by other 'STATUS' messages.



'MANUAL OVERRIDE' is to only be used in emergencies or for servicing. 'MANUAL OVERRIDE' mode automatically disables itself after 30 minutes.

```
S Y S 1 P U M P I N G D O W N
S Y S 2 P U M P I N G D O W N
```

Indicates that a compressor in the respective system is pumping the system down. When pumpdown is initiated, the liquid line solenoid will close and a compressor will continue to run. When the suction pressure decreases to the suction pressure cutout, the compressor will cycle off. If pump down cannot be achieved within three minutes of the liquid line solenoid closure, the compressor will cycle off.

4.2 Fault Status Messages

Safeties are divided into two categories - system safeties and unit safeties. System safeties are faults that cause the individual system to be shut down. Unit safeties are faults that cause all running compressors to be shut down.

System Safeties

System safeties are faults that cause individual systems to be shut down if a safety threshold is exceeded for 3 seconds. The system will be allowed to restart automatically after the fault condition is no longer present. However, if 3 faults on the same system occur within 90 minutes, that system will be locked out on the last fault. This condition will require a manual reset using the system switch (under 'OPTIONS' key). The switch must be turned off and then back on to clear the lockout fault.

```
S Y S 1 H I G H D S C H P R E S
S Y S 2 H I G H D S C H P R E S
```

The software discharge pressure cut-out is backed-up by a mechanical high pressure cut-out switch located in each refrigerant circuit. The software cut-out assures that the system pressure does not exceed safe working limits. The system will shutdown when the programmable cut-out is exceeded and will be allowed to restart when the discharge pressure falls below the cut-out.

```
S Y S 1 L O W S U C T P R E S S
S Y S 2 L O W S U C T P R E S S
```

The software suction pressure cut-out protects the chiller from an evaporator freeze-up should the system attempt to run with a low refrigerant charge or a restriction in the refrigerant circuit.

At system start, the cut-out is set to 10% of programmed value. During the next 3 minutes the cut-out point is ramped up to the programmed cut-out point. If at any time during this 3 minutes the suction pressure falls below the ramped cut-out point, the system will stop. This cut-out is ignored for the first 30 seconds of system run time to avoid nuisance shutdowns.

After the first 3 minutes, if the suction pressure falls below the programmed cut-out setting, a 'transient protection routine' is activated. This sets the cut-out at 10% of the programmed value and ramps up the cutout over the next 30 seconds. If at any time during this 30 seconds the suction pressure falls below the ramped cutout, the system will stop.

```
S Y S 1 M P / H P C O I N H I B I T
S Y S 2 M P / H P C O I N H I B I T
```

OR

```
S Y S 1 M P / H P C O F A U L T
S Y S 2 M P / H P C O F A U L T
```

The Motor Protector (-FMP) / Compressor Overload (-KCOL) / Mechanical High Pressure Cut-outs (-FHP) protect the compressor from overheating, overcurrent or the system from experiencing dangerously high discharge pressure. Compressor overloads are not fitted to YLAA units.



This fault condition is present when relays (1-K1 (system 1) or 2-K1 (system 2) on YCWL/YCRL units or -ARB K20 (system 1) or -ARB K21 (system 2) on YLAE/YLAA units) de-energise due to the -FHP cut-out, or the -FMP opening, or the -KCOL tripping.

-FMP

The compressor electronic modules are connected to the motor winding temperature sensors and an internal discharge temperature sensor. The -FMP opens when the discharge temperature is above 140°C or when the winding temperature rises above the trip temperature. The winding and discharge sensors are connected in series and have a trip resistance of 4.5 kΩ ± 20%, reset is less than 2.75 kΩ. The compressor electronic module has a 30 ± 5 minute reset delay after the sensor reset resistance is reached. For compressors with no electronic module, the compressor has thermostats imbedded in the motor winding whose contacts open on high motor temperatures. when the motor cools the contacts will close again.

-KCOL (YLAE and YCWL/YCRL Units only)

Each compressor contactor is fitted with a thermal overload to provide single phase and overload protection to EN60947-4-1 tripping category class 10 A. The overload requires resetting after a trip.

-FHP

On YLAA models the mechanical HP switch opens at 38.7 barg.

On YLAE models the first mechanical (manual reset) HP switch opens at 38.7 barg. On models 0255SE / 0265HE and above a second mechanical HP switch is fitted, this opens at 40.3 barg.

On YCWL/YCRL models the first mechanical (manual reset) HP switch opens at 34.7 barg. The second mechanical HP switch opens at 36.3 barg.

The 'SYS MP/HPCO INHIBIT' message indicates that if the shutdown was due to a motor protector, that when the motor protector resets the system will restart automatically. If the shut down was due to the mechanical high pressure cut-out, then the cut-out must be reset before the system can restart.

The 'SYS MP/HPCO FAULT' message indicates that the system has locked out and requires a electrical reset, in the case of a mechanical high pressure cut-out, a device reset.

Unit Safeties

Unit safeties are faults that cause all running compressors to be shut down.

UNIT FAULT :
LOW LIQUID TEMP

The low leaving chilled liquid temperature cut-out protects the chiller from an evaporator freeze-up should the chilled liquid temperature drop below the freeze point. This situation could occur under low flow conditions or if the microprocessor setpoint values are improperly programmed. Anytime the leaving chilled liquid temperature (water or glycol) drops below the cut-out point, the chiller will shutdown. Restart can occur when chilled liquid temperature rises 1.2°C above the cut-out.

UNIT FAULT :
115VAC UNDER VOLTAGE

The under voltage safety assures that the system is not operated at voltages where malfunction of the microprocessor could result in system damage. When the 115 Vac to the microprocessor drops below the limit, a unit fault is initiated to safely shut down the unit. Restart is allowed when the 115 Vac is within limits and the anti-recycle timers have finished counting down,

unless MANUAL POWER FAIL RESTART is programmed under the OPTION key. In this case the unit switch must be set to OFF then back to ON to reset this trip.

YLAA and YLAE Units with Optional Hydro Kit

UNIT FAULT :
PUMP TRIP

On units with one pump: This indicates the manual motor starter protecting the pump from short circuit or overload conditions has tripped or been set to OFF. Setting the device to on will reset the trip.

On units with two pumps, duty and standby: This indicates that both the manual motor starters protecting the pumps from short circuit or overload conditions have tripped or both have been set to OFF. Setting at least one of the devices to on will reset the trip.

UNIT FAULT :
PUMP FAIL MAKE FLOW

On units with one pump: After the 30 second stop to start timer has timed out, the pump is started if there is a 'Leaving Liquid Temperature Cutout', or any of the compressors are running, or with the daily schedule not calling for a shutdown with the unit switch on and the remote stop/start input closed (terminals 13 & 14 on -ARB circuit board). If the flow switch does not close within 10 seconds the unit locks out on UNIT FAULT: PUMP FAIL MAKE FLOW and the pump is stopped. Setting the unit switch to OFF then back to ON will reset the trip.

On units with two pumps, duty and standby: After the 30 second stop to start timer has timed out the pump is started if there is a 'Leaving Liquid Temperature Cutout', or any of the compressors are running, or with the daily schedule not calling for a shutdown with the unit switch on and the remote stop/start input closed (terminals 13 & 14 on -ARB circuit board). If the flow switch does not close within 10 seconds the running pump is stopped and the standby pump is started. If in a further 10 seconds the flow switch does not close the unit locks out on UNIT FAULT: PUMP FAIL MAKE FLOW and the running pump is stopped. Setting the unit switch to OFF then back to ON will reset the trip. In attempting to clear this fault check that one of the manual motor starters protecting the pumps has not tripped.

Unit Warning

The low battery message is not a unit safety and will not be logged to the history buffer. It is a unit warning and will not auto-restart. Operator intervention is required to allow a re-start of the chiller.

**!! LOW BATTERY !!
CHECK PROG / SETP / OPTN**

The low battery warning will only occur at microprocessor power-up, when the RTC battery is checked. If a low battery is found, all programmed setpoints, program values, options, time, schedule, and history buffers will be lost. These values will all be reset to their default values which may not be the desired operating values.

Once a faulty battery is detected, the unit will be prevented from running until the 'PROGRAM' key is pressed. Once 'PROGRAM' is pressed the anti-recycle timers will be set to allow the operator time to check setpoints, program values, and options.



If a low battery is detected, it should be replaced as soon as possible. The programmed values will all be lost and the unit will be prevented from running on the next power interruption. The RTC/battery is located at U5 on the IPU II board.

5 Display/Print Keys

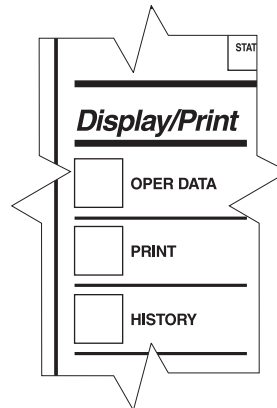

The Display/Print keys allow the user to retrieve system and unit information that is useful for monitoring chiller operation, diagnosing potential problems, troubleshooting, and commissioning the chiller.

System and unit information, unit options, setpoints, and scheduling can also be printed out with the use of an optional printer. Both real-time and history information are available.

5.1 OPER DATA Key

The 'OPER DATA' key gives access to unit and system operating parameters. When the 'OPER DATA' key is pressed, system parameters will be displayed and remain on the display until another key is pressed. After pressing the 'OPER DATA' key, the operating data messages can be scrolled through by using the 'UP ARROW' and 'DOWN ARROW' keys.

The following operating data messages will be displayed in the order shown:

L C H L T = 6 . 2 ° C

This display shows chilled leaving liquid temperature. The minimum display limit is -19.0°C and the maximum display limit is 60.1°C.

**A M B I E N T A I R T E M P
< - 1 7 . 4 ° C**

This display shows the ambient air temperature. YLAA and YLAE units only.

The minimum display limit is -17.4°C and the maximum display limit is 55.2°C.

On YCWL/YCRL units the display will read < -17.4C

```
S Y S 1 S P = 3 . 3 9 B A R G
      D P = 1 5 . 6 B A R G
```

This display shows suction and discharge pressures. The minimum display limit for suction and discharge pressure is 0 barg. The maximum display limit for suction pressure is 27.58 barg and for discharge pressure is 44.7 barg.

The above messages will be repeated sequentially for System 2.

```
S Y S X H O U R S 1 = X X X X X
      2 = X X X X X 3 = X X X X X
```

```
S Y S X S T A R T S 1 = X X X X X
      2 = X X X X X 3 = X X X X X
```

The above two messages will appear sequentially for each system. The first display shows accumulated running hours of each compressor for the specific system. The second message shows the number of starts for each compressor on each system.

```
L O A D T I M E R = 5 8 S E C
U N L O A D T I M E R = 0 S E C
```

This message shows the status of the load and unload timers in seconds until the unit can load or unload. Whether the unit loads or unloads is determined by how far the actual liquid temperature is from the 'SETPOINT'. Refer to capacity control for details of unit loading and unloading.

```
T E M P E R R O R 1 0 . 1 ° C
T E M P R A T E 0 . 7 ° C / M
```

The first line of this message shows the temperature error. That is the difference between the actual leaving chilled liquid temperature and the 'Setpoint High/Low Limit' ('SETPOINT' plus/minus 'CONTROL RANGE'). Within the control range the error is zero. The second line shows the rate of change of leaving chilled liquid temperature. Refer to capacity control for further details.

```
L E A D S Y S T E M I S
S Y S T E M N U M B E R 2
```

This message indicates the current lead system. In the example system 2 is the lead system, making system 1 the lag system. The lead system can be manually or automatically selected. Refer to the 'Options' key for details.

```
E V A P O R A T O R H E A T E R
S T A T U S I S O F F
```

Displayed on YLAA and YLAE units only.

```
E V A P O R A T O R W A T E R
P U M P S T A T U S I S O N
```

This message indicates the status of the evaporator pump contact. After the 30 second stop to start timer has timed out the pump is started by closing a contact (terminals 23 and 24 on -ARB circuit board on YLAA and YLAE units and 23 and 24 on -XTBC2 on YCWL/YCRL units), if there is a 'Leaving Liquid Temperature Cutout', or any of the compressors are running or with the daily schedule not calling for a shutdown with unit switch on and the remote stop/start input closed (terminals 13 and 14 on -ARB circuit board on YLAA and YLAE units and 13 and 51 on -XTBC1 on YCWL/YCRL units).

```
E V A P O R A T O R W A T E R
P U M P S T A T U S Y Y Y Y
```

YYYY = ON, OFF, TRIP

On YLAA and YLAE units fitted with optional Hydro Kit, the above message relates to the unit internal pump.

On dual pump Hydro Kits the following messages are displayed:

```
E V A P O R A T O R W A T E R
P U M P 1 S T A T U S Y Y Y Y
```

```
E V A P O R A T O R W A T E R
P U M P 2 S T A T U S Y Y Y Y
```

YYYY = ON, OFF, TRIP

```
E V A P P U M P T O T A L R U N
H O U R S = 3 2
```

This message indicates the total hours that the pump contact is closed (terminals 23 and 24 on -ARB circuit board on YLAA and YLAE units and 23 and 24 on -XTBC2 on YCWL/YCRL units)

If the optional Hydro Kit is fitted the above message relates to the unit internal pump.

On dual pump Hydro Kits the following messages are displayed:

```
P U M P N O 1 T O T A L R U N
H O U R S = 3 2
```

```
P U M P N O 2 T O T A L R U N
H O U R S = 1 2
```

There are several types of remote systems that can be used to control or monitor the unit. The following messages indicate the type of remote control mode active:

```
ACTIVE REMOTE CTRL
      NONE
```

No remote control active. Remote monitoring may be via ISN.

```
ACTIVE REMOTE CTRL
      ISN
```

YorkTalk via ISN (Remote Mode).

```
ACTIVE REMOTE CTRL
      LOAD LIM
```

Load limiting enabled. Can be either stage 1 or stage 2 of limiting.

```
ACTIVE REMOTE CTRL
      PWM TEMP
```

EMS-PWM temperature reset.

The following messages will appear sequentially, first for system 1, then for system 2.

```
CONDENSER PUMP
STATUS IS ON
```

```
SYS X RUNTIME
XX - XX - XX - XX D - H - M - S
```

```
SYS X COMP STATUS
1 = OFF 2 = OFF 3 = ON
```

```
SYS X LLSV IS ON
```

```
SYS X FAN VFD SIGNAL
X.X VOLTS = XXX%
```

```
SYS X FAN STAGE 2
```

The first message indicates the status (ON or OFF) of each compressor in the system.

The second message indicates the system run time in days - hours - minutes - seconds.



This is not accumulated run time but only the current system cycle.

The third indicates the system, and whether the liquid line solenoid is being commanded on by the microprocessor.

Message 4 is not used.

On YLAA and YLAE units the fifth message indicates what stage of condenser fan operation is active. On YCWL/YCRL units the message is not applicable.

YLAE Single Speed Fans only - System 1 & 2 models 0190SE to 0255SE, 0330SE & 0195HE to 0265HE, System 1 model 0315SE. Only stages 1 and 2 will be used to cycle the condenser fans. However, stage 3 may be shown, but it has no effect.

Units with Two Speed Fans

The YLAE two speed fan messages are as follows:

The message on units with 2 fans per system will be:

```
SYS 1 1 = XXXX
FANS 2 = XXXX
```

The message on units with 3 fans per system will be:

```
SYS 1 1 = XXXX 2 = XXXX
FANS 3 = XXXX
```

The message on units with 4 fans per system will be:

```
SYS 1 1 = XXXX
FANS 2 & 3 = XXXX 4 = XXXX
```

Where the fan status of each fan can be OFF, SLOW or FAST.

The YLAA two speed fan messages are as follows:

```
SYS X FAN STAGE ZZZZ
```

ZZZZ = OFF, LO Y or HI Y where Y is 1, 2 3, or 4

YLAE and YLAA Units

If fan full speed inhibit is in effect when the fans would otherwise be required to run at full speed the message changes to:

```
SYS X FANS SLOW
FAN SPEED INHIBIT
```

5.2 PRINT Key

The 'PRINT' key allows the operator to obtain a printout of real-time system operating data or a printout of system data at the "instant of the fault" on the last six faults which occurred on the unit. An optional printer is required for the printout.

Operating Data Print-out

Pressing the 'PRINT' key and then 'OPER DATA' key allows the operator to obtain a printout of current system operating parameters. When the 'OPER DATA' key is pressed, a snapshot will be taken of system operating conditions and panel programming selections. This data will be temporarily stored in memory and transmission of this data will begin to the printer. A sample operating data printout is shown opposite.

```

YORK INTERNATIONAL CORPORATION
MILLENNIUM LIQUID CHILLER

UNIT STATUS
10:01AM 11 APR 08

SYS 1 COMPRESSORS RUNNING 2
SYS 2 COMPRESSORS RUNNING 3

OPTIONS

CHILLED LIQUID WATER
LOCAL/REMOTE MODE REMOTE
LEAD/LAG CONTROL AUTOMATIC
POWER FAIL RESTART MANUAL
EXPANSION VALVE THERMOSTATIC
REMOTE TEMP RESET 0 TO 10 V
YORK HYDRO KIT PUMPS = 1
HOT GAS BYPASS TYPE NONE

PROGRAM VALUES

DSCH PRESS CUTOUT 38.6 BARG
SUCTION PRESS CUTOUT 5.59 BARG
LOW AMBIENT CUTOUT -3.9 DEGC
LEAVING LIQUID CUTOUT 3.0 DEGC
ANTI RECYCLE TIME 600 SECS
FAN CONTROL ON PRESS 23.1 BARG
FAN DIFF OFF PRESS 5.5 BARG
NUMBER OF COMPRESSORS 6
SYS1 NUMBER OF FANS 4
SYS2 NUMBER OF FANS 4
REFRIGERANT TYPE R-410A
REMOTE UNIT ID PROGRAMMED 0
RATE SENSITIVITY 2.0 DEGC/MIN
RATE CONTROL RANGE TMP 6.1 DEGC

UNIT DATA

RETURN LIQUID TEMP 11.2 DEGC
LEAVING LIQUID TEMP 6.2 DEGC
COOLING RANGE 6.1 +/- 1.1 DEGC
REMOTE SETPOINT 6.1 DEGC
AMBIENT AIR TEMP 11.3 DEGC
LEAD SYSTEM SYS 2
EVAPORATOR PUMP ON
EVAPORATOR HEATER OFF
ACTIVE REMOTE CONTROL TEMP
EVAP PUMP TOTAL RUN HOURS 83
SOFTWARE VERSION C.M17.16.02

SYSTEM 1 DATA

COMP STATUS 1=OFF 2=ON 3=ON
RUN TIME 0- 1- 8-33 D-H-M-S
SUCTION PRESSURE 8.14 BARG
DISCHARGE PRESSURE 24.4 BARG
LIQUID LINE SOLENOID ON
CONDENSER FAN STAGE LO 4

SYSTEM 2 DATA

COMP STATUS 1=ON 2=ON 3=ON
RUN TIME 0- 1-13-44 D-H-M-S
SUCTION PRESSURE 7.45 BARG
DISCHARGE PRESSURE 27.1 BARG
LIQUID LINE SOLENOID ON
CONDENSER FAN STAGE HI 4

DAILY SCHEDULE

S M T W T F S *=HOLIDAY
SUN START=00:00AM STOP=00:00AM
MON START=00:00AM STOP=00:00AM
TUE START=00:00AM STOP=00:00AM
WED START=00:00AM STOP=00:00AM
THU START=00:00AM STOP=00:00AM
FRI START=00:00AM STOP=00:00AM
SAT START=00:00AM STOP=00:00AM
HOL START=00:00AM STOP=00:00AM
    
```

History Print-out

Pressing the 'PRINT' key and then the 'HISTORY' key allows the operator to obtain a printout of information relating to the last 6 Safety Shutdowns which occurred. The information is stored at the instant of the fault, regardless of whether the fault caused a lockout to occur. The information is also not affected by power failures or manual resetting of a fault lock-out.

When the 'HISTORY' key is pressed, a printout is transmitted of all system operating conditions which were stored at the "instant the fault occurred" for each of the 6 Safety Shutdowns buffers. The printout will begin with the most recent fault which occurred. The most recent fault will always be stored as Safety Shutdown No. 1. Identically formatted fault information will then be printed for the remaining safety shutdowns.

Information contained in the Safety Shutdown buffers is very important when attempting to troubleshoot a system problem. This data reflects the system conditions at the instant the fault occurred and often reveals other system conditions which actually caused the safety threshold to be exceeded.

The history printout is identical to the operational data printout with the exception of the header and the schedule information which is not printed. An example of a history buffer header printout is shown opposite.

```

YORK INTERNATIONAL CORPORATION
MILLENNIUM LIQUID CHILLER

SAFETY SHUTDOWN NUMBER 1
SHUTDOWN @ 8:46AM 11 APR 08

SYS 1 LOW SUCTION PRESS SHUTDOWN
SYS 2 NO FAULTS

OPTIONS

CHILLED LIQUID WATER
LOCAL/REMOTE MODE REMOTE
LEAD/LAG CONTROL AUTOMATIC
POWER FAIL RESTART MANUAL
EXPANSION VALVE THERMOSTATIC
REMOTE TEMP RESET 0 TO 10 V
YORK HYDRO KIT PUMPS = 1
HOT GAS BYPASS TYPE NONE

PROGRAM VALUES

DSCH PRESS CUTOUT 38.6 BARG
SUCTION PRESS CUTOUT 5.59 BARG
LOW AMBIENT CUTOUT -17.8 DEGC
LEAVING LIQUID CUTOUT 3.0 DEGC
ANTI RECYCLE TIME 600 SECS
FAN CONTROL ON PRESS 25.1 BARG
FAN DIFF OFF PRESS 4.1 BARG
NUMBER OF COMPRESSORS 6
SYS1 NUMBER OF FANS 4
SYS2 NUMBER OF FANS 4
REFRIGERANT TYPE R-410A
REMOTE UNIT ID PROGRAMMED 0
RATE SENSITIVITY 1.7 DEGC/MIN
RATE CONTROL RANGE TMP 6.1 DEGC

UNIT DATA

RETURN LIQUID TEMP 11.2 DEGC
LEAVING LIQUID TEMP 7.6 DEGC
COOLING RANGE 6.1 +/- 1.1 DEGC
REMOTE SETPOINT 6.1 DEGC
AMBIENT AIR TEMP 11.2 DEGC
LEAD SYSTEM SYS 1
EVAPORATOR PUMP ON
EVAPORATOR HEATER OFF
ACTIVE REMOTE CONTROL TEMP
EVAP PUMP TOTAL RUN HOURS 81
SOFTWARE VERSION C.M17.16.02

SYSTEM 1 DATA

COMP STATUS 1=ON 2=ON 3=ON
RUN TIME 0- 0- 2-59 D-H-M-S
SUCTION PRESSURE 5.24 BARG
DISCHARGE PRESSURE 28.7 BARG
LIQUID LINE SOLENOID ON
CONDENSER FAN STAGE LO 4

SYSTEM 2 DATA

COMP STATUS 1=OFF 2=OFF 3=OFF
RUN TIME 0- 0- 0- 0 D-H-M-S
SUCTION PRESSURE 7.45 BARG
DISCHARGE PRESSURE 20.8 BARG
LIQUID LINE SOLENOID OFF
CONDENSER FAN STAGE OFF

```

5.3 History Key

The 'HISTORY' key displays unit and system operating parameters at the time of a unit or system safety shutdown.

5.3.1 Clearing History Buffers

The history buffers may be cleared by pressing the 'HISTORY' key and then repeatedly pressing the 'UP ARROW' key until you scroll past the last history buffer choice. The following message will be displayed:

```
INITIALIZE HISTORY
ENTER = YES
```

Pressing the 'ENTER/ADV' key at this display will cause the history buffers to be cleared. Pressing any other key will cancel the operation.

5.3.2 History Messages

When the 'HISTORY' key is pressed the following message is displayed.

```
DISPLAY SAFETY SHUT-
DOWN NO. 1 ( 1 TO 6)
```

While this message is displayed, the 'UP ARROW' or 'DOWN ARROW' keys can be used to select any of the six history buffers. Buffer number 1 is the most recent, and buffer number 6 is the oldest safety shutdown that was saved.

After selecting the shutdown number, pressing the 'ENTER' key displays the following message which shows when the shutdown occurred.

```
SHUT DOWN OCCURRED
11:23 PM 29 MAY 98
```

The 'UP ARROW' and 'DOWN ARROW' keys are used to scroll forwards and backwards through the history buffer to display the shutdown conditions. The history data messages are shown below in the order that they are displayed:

```
UNIT FAULT :
LOW LIQUID TEMP
```

```
UNIT TYPE
LIQUID CHILLER
```

```
CHILLED LIQUID
WATER
```

```
LOCAL / REMOTE MODE
LOCAL
```

```
LEAD / LAG CONTROL
AUTOMATIC
```

```
MANUAL OVERRIDE MODE
DISABLED
```

```
POWER FAIL RESTART
AUTOMATIC
```

```
EXTERNAL
EVAP PUMP
```

For YLAA and YLAE units

```
YORK HYDRO KIT
PUMP = 1
```

Or

```
YORK HYDRO KIT
PUMP = 2
```

```
DISCHARGE PRESSURE
CUTOUT = 25.7 BARG
```

```
SUCTION PRESSURE
CUTOUT = 3.03 BARG
```

```
LOW AMBIENT TEMP
CUTOUT = -17.8 °C
```

```
LEAVING LIQUID TEMP
CUTOUT = 2.2 °C
```

```
LCHLT = 6.2 °C
```

```
SETPOINT = 6.7 °C
RANGE = +/- 1.1 °C
```

```
AMBIENT AIR TEMP
< -17.4 °C
```

```
LEAD SYSTEM IS
SYSTEM NUMBER 1
```

```
EVAPORATOR HEATER
STATUS IS OFF
```

```
EVAPORATOR WATER
PUMP STATUS IS ON
```

OR for YLAA/YLAE units with Hydro Kit Option

```
EVAPORATOR WATER
PUMP STATUS YYYY
```

YYYY = ON, OFF, TRIP

OR for YLAA/YLAE units with Dual Pump Hydro Kit Option

```
EVAPORATOR WATER
PUMP 1 STATUS YYYY
```

```
EVAPORATOR WATER
PUMP 2 STATUS YYYY
```

YYYY = ON, OFF, TRIP

```
EVAP PUMP TOTAL RUN
HOURS = 29
```

OR for YLAA/YLAE units with Hydro Kit Option

```
PUMP TOTAL RUN
HOURS = 37
```

OR for YLAA/YLAE units with Dual Pump Hydro Kit Option

```
PUMP NO1 TOTAL RUN
HOURS = 32
```

```
PUMP TOTAL RUN
HOURS = 12
```

```
ACTIVE REMOTE CTRL
NONE
```

```
RATE SENSITIVITY
= 1.7 °C / MIN
```

```
RATE CONTROL TEMP
= 1.6 °C
```

```
SYS X COMP STATUS
1 = OFF 2 = OFF 3 = ON
```

```
SYS 1 RUN TIME
00 - 1 - 46 - 15 D - H - M - S
```

```
SYS 1 SP = 2.97 BARG
DP = 15.66 BARG
```

```
SYS X LLSV IS ON
```



Other messages may be shown, which are applicable to YLAA and YLAE units only.

The System 1 messages above are repeated for System 2. Explanations of the history data messages are given under the 'STATUS', 'DISPLAY/PRINT', 'SETPOINTS' or 'UNIT' keys.

5.3.3 Software Version

The software version may be viewed by pressing the 'HISTORY' key and then repeatedly pressing the 'DOWN ARROW' key until you scroll past the first history buffer choice. The following messages are an example of what will be displayed:

```
SOFTWARE VERSION
CM . MC . ZZ . YY
```

OR

```
SOFTWARE VERSION
CM . XX . ZZ . YY
```

Where:

C is the Product Classification and stands for

Commercial Unit

MMC or M is the Family Code and stands for

Middle Market

XX is the Field Revision Number.

ZZ = 16 which is the Product Code.

YY = 00 which is the Version Number.

6 ENTRY KEYS

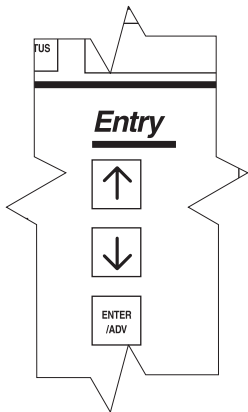

The Entry Keys allow the programmed values to be viewed and changed.

6.1 UP ARROW and DOWN ARROW Keys

Used in conjunction with the 'OPER DATA' and 'HISTORY' keys, the 'UP ARROW' and 'DOWN ARROW' keys allow the user to scroll through the data messages.

The 'UP ARROW' and 'DOWN ARROW' keys are also used for programming the control panel when changing cooling setpoints, setting the daily schedule, changing safety setpoints, chiller options, and setting the clock.

6.2 ENTER/ADV Key

The 'ENTER' key must be pushed after any change is made during programming to enter the new value into memory. If the 'ENTER' key is not pressed after a value is changed, the changes will not be 'entered' and the original values will be used to control the chiller.

7 SETPOINTS KEYS

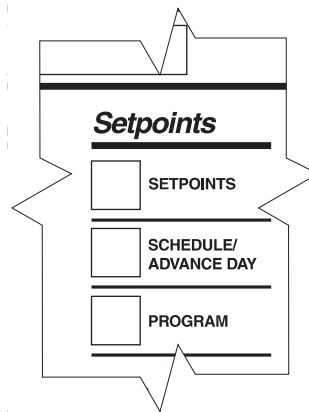

Programming and viewing the cooling setpoints, daily schedule, and safeties is accomplished by using the 'SETPOINTS' keys:

7.1 Cooling Setpoints

The cooling 'SETPOINT' and 'RANGE' can be viewed or programmed by pressing the 'SETPOINTS' key (Refer to Section 7.5 Setpoint Settings). After pressing the key the 'SETPOINT' and 'RANGE' entry message is displayed:

S	E	T	P	O	I	N	T	=		6	.	7	°	C			
R	A	N	G	E	=					+	/	-	1	.	1	°	C

The above message shows the current chilled water temperature 'SETPOINT' at 6.7°C (the cursor is positioned under the number 6). Pressing the 'UP ARROW' or 'DOWN ARROW' will change the 'SETPOINT' in 0.2°C to 0.3°C increments. The 'ENTER/ADV' key must be pressed to enter the 'SETPOINT' into memory and advance to the 'RANGE'.

The cursor will move under the current 'RANGE' setting. Pressing the 'UP ARROW' or 'DOWN ARROW' will change the setting between 0.8°C, 1.1°C and 1.4°C. The 'ENTER/ADV' key must be pressed to enter the range into memory.

The 'RANGE' setting takes into account the number of compressors on the unit and the temperature difference between leaving (LCHLT) and return chilled liquid at full load.



The 'RANGE' is programmed for +/- X.X° C. The 'SETPOINT' is in the centre of the control range.

For further details of cooling setpoint programming refer to Capacity Control.

Pressing the 'SETPOINTS' key a second time will display the remote 'SETPOINT' and 'RANGE'. The range value is the value entered under the previous display:

```

R E M   S E T P   =   6 . 7 ° C
R A N G E   =   + / - 1 . 1 ° C
  
```

This message automatically updates every 2 seconds. This setpoint is not programmable, but is controlled by a remote device such as an ISN control or EMS-PWM temperature reset signal. This setpoint would only be valid if the unit is operating in the 'REMOTE' mode.

Pressing the 'SETPOINTS' a third time will allow the maximum remote EMS-PWM temperature reset to be programmed:

```

M A X   E M S - P W M   R E M O T E
T E M P   R E S E T   =   1 1 . 0 ° C
  
```

The temperature reset value is the maximum allowable reset of the temperature 'SETPOINT'. The 'SETPOINT' can be reset upwards by the use of a timed contact closure on the PWM input (-XTBC1 terminals 13 - 20) Activated on request.

Pressing the 'UP ARROW' or 'DOWN ARROW' will change the temperature reset value in 1.0°C increments. The 'ENTER/ADV' key must be pressed to enter the value into memory.

```

L A S T   R U N   T I M E   =   1 6 7 S
S E T P   A D J U S T   =   1 . 7 ° C
  
```

Pressing the 'SETPOINTS' a fourth time will display the lead system's last run time and the setpoint adjust value. See Capacity Control (Section 2.1).

7.2 SCHEDULE/ADVANCE DAY Key

The microprocessor features a continuously running internal clock and calendar and can display actual time as well as the day of the week and the date. An automatic schedule feature is provided for starting and stopping the chiller on individual days of the week, eliminating the need for an external time clock. Also provided are a holiday feature, allowing special start/stop times to be set for designated holidays.

If the automatic schedule feature is not required, the microprocessor can be programmed to run the chiller on demand as long as the chiller ON/OFF and system switches are in the ON position. The daily schedule is considered 'not programmed' when the times in the schedule are all zeros (00:00 AM).

Programming of the operating and holiday schedules are described below.

To set the schedule, press the 'SCHEDULE/ADVANCE DAY' key. The display will show the following message:

```

M O N   S T A R T   =   0 0 : 0 0   A M
                S T O P   =   0 0 : 0 0   A M
  
```

The cursor will be under the 0. The time may be changed by using the 'UP ARROW' and 'DOWN ARROW' keys. Pressing the 'ENTER/ADV' key will enter the time and then move the cursor to the minute box. This process should be repeated until the hour, minutes, and meridian (AM or PM) of both the 'START' and 'STOP' times are set. After setting the meridian of the stop time, pressing the 'ENTER/ADV' key will advance the schedule to the next day.



Whenever the daily schedule is changed for Monday, all the other days will change to the new Monday schedule. This means if the Monday times are not applicable for the whole week then the individual days would need to be reprogrammed to the desired schedule.

To page to a specific day press the 'SCHEDULE/ADVANCE DAY' key. The start and stop time of each day may be programmed differently using the 'UP ARROW' and 'DOWN ARROW' and 'ENTER/ADV' keys.

After the Sunday schedule appears on the display a subsequent press of the 'SCHEDULE/ADVANCE DAY' key will display the Holiday schedule. This is a two part message. The first reads:

```
H O L   S T A R T   =   0 0 : 0 0   A M
                   S T O P   =   0 0 : 0 0   A M
```

The times may be set using the same procedure as described above for the days of the week. After changing the meridian of the stop time, pressing the 'ENTER/ADV' key will advance the schedule to the following display:

```
S _ M T W T F S
H O L I D A Y   N O T E D   B Y   *
```

The line below the empty space next to the 'S' is the cursor and will move to the next empty space when the 'ENTER/ADV' key is pressed. To set the Holiday, the cursor is moved to the space following the day of the week of the holiday and the 'UP ARROW' key is pressed. An '*' (asterisk) will appear in the space signifying that day as a holiday. The '*' (asterisk) can be removed by pressing the 'DOWN ARROW' key.



The holiday schedule must be reprogrammed after holiday, because once the holiday schedule runs it will revert to the normal daily schedule.

7.3 PROGRAM Key

The 'PROGRAM' key is used to set the programmable cut-outs, timers and switching points. These parameters can be changed by pressing the 'PROGRAM' key, and then the 'ENTER/ADV' key to enter the program mode. Continuing to press the 'ENTER/ADV' key will display each operating parameter. While a particular parameter is being displayed, the 'UP ARROW' and 'DOWN ARROW' keys can be used to change the value (Refer to Section 7.5 Cut-out Settings). After the value is changed, the 'ENTER/ADV' key must be pressed to enter the new parameter into memory .

The programmable parameters are displayed in the following order:

```
D I S C H A R G E   P R E S S U R E
C U T O U T   =   2 6 . 7 B A R G
```

The discharge pressure cut-out is the pressure at which the system will shutdown as monitored by the discharge pressure transducer. This cut-out is backed-up by one or two (dependant on unit size) mechanical (manual reset) HP switches located in each refrigerant circuit.

```
S U C T I O N   P R E S S U R E
C U T O U T   =   3 . 0 3 B A R G
```

The suction pressure cut-out protects the chiller from an evaporator freeze-up. If the suction pressure drops below the cutout point, the system will shut down.



There are some exceptions when the suction pressure is permitted to temporarily drop below the cut-out setting. Refer to System Safeties for details.

```
L O W   A M B I E N T   T E M P
C U T O U T   =   - 1 7 . 8 ° C
```

The low ambient temperature cut-out sets the chiller outside ambient temperature cut-out point. If the ambient temperature falls below this point, the chiller will shut down. Restart can occur when temperature rises 1.11°C above the cut-out setting.

The low ambient temperature cut-out is not used on YCWL/YCRL units and must be set to -17.8°C.

```
L E A V I N G   L I Q U I D   T E M P
C U T O U T   =   2 . 2 ° C
```

The leaving liquid temperature cut-out protects the chiller from an evaporator freeze-up. Anytime the leaving chilled liquid temperature drops to the cut-out point, the chiller shuts down. Restart will be permitted when the leaving chilled liquid temperature rises 1.11°C above the cut-out setting.



When water cooling mode is programmed ('OPTIONS' key), the cut-out is fixed at 3.0°C and cannot be changed. Glycol cooling mode values are programmable.

```
A N T I   R E C Y C L E   T I M E
=   2 4 0   S E C
```

Each system has its own anti-recycle timers. The anti-recycle time under the 'PROGRAM' key can be programmed between 240-600 seconds and sets the minimum start-to-start time of the lead compressor in a system. A second non-programmable anti-recycle timer, stop to start is fixed at 90 seconds, starts to countdown when the lead compressor in a systems cycles off. On power up only this timer is set to 120 seconds not 90 seconds.

The anti-recycle message is displayed when a system is unable to start due to either of the anti-recycle timers being active (counting down). The actual time displayed

will be the longer of the two timers, start-to-start or stop-to-start. The lag compressor in a system, are not controlled by the anti-recycle timer.

**FAN CONTROL ON
PRESSURE = 15.9 BARG**

The fan control ON pressure is the programmed setting that is used to stage the condenser fans on, in relation to discharge pressure (YLAA and YLAE units only).

**FAN DIFFERENTIAL OFF
PRESSURE = 5.52 BARG**

The fan differential OFF pressure is the programmed differential setting that is used to stage the condenser fans off, in relation to discharge pressure (YLAA and YLAE units only).

**TOTAL NUMBER OF
COMPRESSORS = 6**

The total number of compressors setting determines the stages of cooling available.



The total number of compressors must be programmed correctly to ensure proper chiller operation.

**REMOTE UNIT ID
PROGRAMMED = 0**

When the unit is connected to a remote ISN controller this message allows the identification number to be programmed into the unit.

**SYS 1 NUMBER OF FANS
= 3**

**SYS 2 NUMBER OF FANS
= 3**

The total number of fans per system must be programmed correctly to ensure proper chiller operation.

These messages are not applicable on YCWL/YCRL units.

**RATE SENSITIVITY
= 1.7 °C / MIN**

For loading to take place the leaving water temperature must not be falling faster than the programmed value when the temperature is within the 'RATE CONTROL TEMP RANGE'.

**RATE CONTROL TEMP
= 1.6 °C**

This range starts at the top of the control range. Within this range rate sensitivity as programmed above is used. Above this range a fixed 1.7 °C/min is used. Loading is prevented if the leaving water temperature is falling faster than the 'RATE SENSITIVITY' value.

**DUTY / STANDBY PUMP
CHANGE OVER = XX DAYS**

On units with a dual pump hydro kit the duty standby time can be programmed. The DUTY PUMP is the pump with the shortest run hours. Pump duty is changed when the pumps are off or if the duty pump run hours are greater than the 'DUTY/STANDBY PUMP CHANGE OVER DAYS'.

**3 - WAY VALVE RLH
TEMP SET P = XX C**

**3 - WAY VALVE PRESS
DIFF SET P = XXX BARG**

**3 - WAY VALVE VOLTAGE
SET POINT = X.X VOLTS**

**3 - WAY VALVE ON TIME
= XX SECONDS**

The four messages above apply to the YCWL unit only when it is required to influence the position of a 3 way condenser liquid valve on initial start to avoid low pressure trips. See section covering the operation of the 3 way valve output for further information.

7.4 Setpoint and Cut-out Settings



Refer to Operating Limitations in ICOM (035-21170-100) when setting or adjusting Setpoint and Cut-out Settings.

Leaving Liquid SETPOINTS and Programmable Limits and Defaults

Parameter	Type	Low Limit	High Limit	Default
Leaving Liquid 'SETPOINT' ⁽¹⁾	Water Cooling ⁽²⁾	4.4°C	21.1°C	6.7°C
	Glycol Cooling	-7.2°C	21.1°C	6.7°C
	Low Temp Glycol Cooling	-13.3°C	21.1°C	6.7°C
Leaving Liquid 'RANGE'	Water/Glycol	0.8°C	1.4°C	1.1°C
Maximum EMS-PWM Remote Temperature Reset	Water/Glycol	1.0°C	22.0°C	11.0°C

- (1) Contact Johnson Controls for application guidelines before exceeding 12.8°C 'SETPOINT'.
- (2) **Leaving Chilled Liquid 'SETPOINT' should not be set below 5°C for water cooling.**

Cut-outs Programmable Limits, Defaults and Factory Settings

Parameter	Type	Low Limit	High Limit	Default	Factory Setting	
					YCWL	YLAE YLAA
Discharge Pressure Cutout	Water/Glycol	22.4 barg	39.6 barg	38.6 barg	33.8 barg	38.0 barg
Suction Pressure Cutout	Water Cooling	5.52 barg	8.27 barg	6.00 barg	5.52 barg	5.59 barg
	Glycol Cooling	2.90 barg	8.27 barg	6.00 barg	Note (2)	Note (2)
Low Ambient Temperature Cut-out	Water/Glycol	-17.8°C	15.6°C	-3.9°C	-17.8°C	Note (4)
Leaving Chilled Liquid Temperature Cut-out	Water Cooling			3.0°C	3.0°C	3.0°C
	Glycol Cooling	-13.1°C	3.0°C	3.0°C	Note (2)	Note (2)
	Low Temp Glycol Cooling	-18.3°C	3.0°C	3.0°C	Note (2)	Note (2)
Anti-Recycle Timer	Water/Glycol	240 s	600 s	600 s	600	600
Fan Control On-Pressure YLAA/YLAE units only	Water/Glycol	20.0 barg	33.4 barg	23.0 barg		23.1 barg
Fan Differential Off-Pressure ⁽¹⁾ YLAA/YLAE units only	Water/Glycol	3.7 barg	11.0 barg	5.5 barg		5.5 barg
Total Number Of Compressors	Water/Glycol	4	6	6	Note (3)	Note (3)
Unit ID	Water/Glycol	0	7	0	0	0
System 1 Number of Fans YLAA/YLAE units only	Water/Glycol	2	4	3		Note (5)
System 2 Number of Fans YLAA/YLAE units only	Water/Glycol	2	4	3		Note (5)
Rate Sensitivity	Water/Glycol	1.0°C	8.0°C	1.7°C	1.7°C	1.7°C
Rate Control Temperature	Water/Glycol	1.0°C	11.0°C	6.1°C	6.1°C	6.1°C
Duty/Standby Pump Change Over - Dual Pump Hydro Kit Option		1 Day	30 Days	14 Days		14

- (1) The minimum discharge pressure allowed with any fans running is approximately 16.6 barg.
i.e. Fan Control On Pressure - Fan Differential Off Pressure is not lower than approximately 16.6 BARG
The Discharge Fan Differential Off Pressure high limit is lowered to prevent going below approximately 16.6 barg based on where the Discharge Fan Control On Pressure is programmed.
- (2) Programmed on site to match glycol concentration and site requirements
- (3) Programmed to match number of compressors
- (4) YLAE set to -17.8°C. YLAA standard unit -3.9°C, low ambient unit -17.8°C
- (5) Programmed to match number of fans.

8 Unit Keys

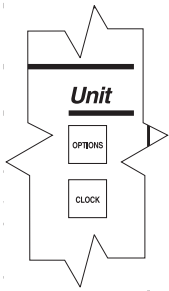

8.1 OPTIONS Key

The 'OPTIONS' key is used to scroll through the list of options by repeatedly pressing the 'OPTIONS' key. The options may be changed using the 'UP ARROW' and 'DOWN ARROW' keys. After an option is changed the 'ENTER/ADV' key must be pressed to enter the setting into memory. The options are displayed in the following order:

DISPLAY LANGUAGE
ENGLISH

One of the display message languages may be selected.

SYS 1 SWITCH ON
SYS 2 SWITCH ON

or

SYS 1 SWITCH OFF
SYS 2 SWITCH OFF

or

SYS 1 SWITCH ON
SYS 2 SWITCH OFF

or

SYS 1 SWITCH OFF
SYS 2 SWITCH ON

The System Switches can be set to allow both systems to run, stop both systems or only one system to run.

CHILLED LIQUID
WATER

or

CHILLED LIQUID
GLYCOL

The chilled liquid type can be set for water or glycol.

LOCAL / REMOTE MODE
LOCAL

or

LOCAL / REMOTE MODE
REMOTE

When programmed for 'LOCAL' an ISN, Bacnet or Modbus control can be used to monitor only. The microprocessor will operate on locally programmed values and ignore all commands from the remote devices. The chiller will communicate and send data to the remote monitoring devices.

With 'REMOTE' selected an ISN, Bacnet or Modbus can be used to control the chiller. This mode will allow the ISN to control the following items: Remote Start/Stop, Leaving Liquid Setpoint, Load Limit, Mode (Cooling or Heating) and History Buffer Request. For Bacnet or Modbus the following items can be controlled: Leaving Liquid Setpoint, Load Limit and Mode (Cooling or Heating). If the unit receives no valid ISN transmission for 5 minutes, it will revert back to the locally programmed values.

DISPLAY UNITS
IMPERIAL

or

DISPLAY UNITS
SI

Display messages can be shown in Imperial units (°F or PSI) or SI units (°C or Bar).

LEAD / LAG CONTROL
MANUAL SYS 1 LEAD

or

LEAD / LAG CONTROL
MANUAL SYS 2 LEAD

or

LEAD / LAG CONTROL
AUTOMATIC

System 1 or system 2 can be selected as the lead system under manual or the microprocessor will determine which system is assigned to the lead and lag under automatic. A new lead/lag assignment is made whenever all compressors are shut down in automatic. The microprocessor will then assign the lead to the system compressor with the shortest average run time.

MANUAL OVERRIDE MODE
DISABLED

or

MANUAL OVERRIDE MODE
ENABLED

This option allows the programmed daily schedule to be overridden for service tasks when the mode is enabled. It will automatically be disabled after 30 minutes.

POWER FAIL RESTART
AUTOMATIC

or

POWER FAIL RESTART
MANUAL

If automatic is set the unit will restart automatically after a power failure with the unit anti recycle timers counting down from 120 seconds.

If manual is set then after a power failure the status message will read 'UNIT FAULT: 115VAC UNDER VOLTAGE'. To restart the unit, the unit switch (under the key pad) must be set to 'OFF' then back to 'ON'.

SOFT START
ENABLED

This message must only be displayed when the unit is fitted with soft starters. On units not fitted with soft start the message will not be displayed. If the option is incorrect, contact your local YORK / Johnson Controls service office.

UNIT TYPE
LIQUID CHILLER

This option is factory set and should always read LIQUID CHILLER. If a unit type other than liquid chiller is displayed contact your local YORK / Johnson Controls service office.

REFRIGERANT TYPE
R410A

This option is factory set and should always read R410A. If the refrigerant type is incorrect contact your local YORK / Johnson Controls service office.

FLASH CARD UPDATE
DISABLED

This option should read DISABLED, do not change to ENABLED.

REMOTE TEMP RESET
INPUT DISABLED

OR

REMOTE TEMP RESET
INPUT 0 TO 10.0V

OR

REMOTE TEMP RESET
INPUT 2 TO 10.0V

OR

REMOTE TEMP RESET
INPUT 0 TO 20MA

OR

REMOTE TEMP RESET
INPUT 4 TO 20MA

If the temperature input is not used ensure the option reads DISABLED. If the input is used set to the required type.

EXTERNAL
EVAP PUMP

Or

YORK HYDRO
KIT PUMP = 1

Or

YORK HYDRO
KIT PUMP = 2

This option must be set to reflect if an external evaporator pump or a YORK Hydro kit with single or dual pumps is used. YLAA and YLAE units only.

PUMP SELECTION
AUTOMATIC

Or

PUMP SELECTION
MANUAL PUMP No 1

Or

PUMP SELECTION
MANUAL PUMP No 2

When the dual pump YORK Hydro Kit Option is fitted one of the above selections can be made. When AUTOMATIC is selected the DUTY PUMP is the pump with the shortest run hours. Pump duty is changed when the pumps are off or if the duty pump run hours are greater than the 'DUTY/STANDBY PUMP CHANGEOVER DAYS' (programmed under the program key). If the running pump fails to make flow, or flow is lost, or the pumps manual motor starter trips on overload, the duty pump will be stopped and the standby pump will start.

When MANUAL PUMP No 1 or 2 is selected the selected pump is the only pump available to run.

<p>H O T G A S B Y P A S S T Y P E N O N E</p>
--

No hot gas bypass systems are fitted to this range of units.

8.2 CLOCK Key

Pressing the 'CLOCK' displays the current day, time, and date. It is important that the date and time are correct, otherwise the daily schedule will not function as correctly. In addition, for ease of troubleshooting via the History printouts, the day, time, and date should be correct.

To change the day, time, and date press the 'CLOCK' key. The display will show:

<p>T O D A Y I S T U E 1 7 : 1 5 P M 1 4 D E C 9 9</p>
--

The cursor is positioned under the day. Pressing the 'UP ARROW' or 'DOWN ARROW' will change the day. The 'ENTER/ADV' key must be pressed to enter the value into memory and to move to the next value. The hour, minute, meridian, date, month and year may be programmed in the same manner.



Jumper J11 on the microprocessor board must be set to the 'CLKON' position to turn on the clock. If this is not done the clock will not function.

9 OPTIONAL SOFT START



Always isolate the unit supply before removing the compressor motor terminal box covers. On compressors with soft start fitted phase L2 of the starter is uncontrolled and thus the motor terminals will be LIVE even with the compressor OFF, unless the unit supply is isolated.

Optional soft start is fitted to the last compressor to start in each system. The soft starter controls the inrush current by switching the voltage to the compressor motor phases L1 and L3. The starter characteristics are specifically matched to the needs of the scroll compressors to ensure trouble free starting and to meet lubrication requirements by acceleration to full speed within 0.8 of a second. At the end of the voltage ramp up time an internal bypass contactor will operate.

The soft starter is provided with two status LED's: READY light will be ON as soon as the control circuit supply is turned ON. During the start-up ramp the READY light will flash, but the flashing may not be detectable due to the short ramp up time. The READY and BYPASS lights will be on when the compressor is running.

9.1 Diagnostics

If the READY light is OFF check the control supply 110V to soft starter terminal A1 and A2.

READY light On No BYPASS light ON, compressor expected to start. Check for 110V on soft starter terminals 1(IN) and A2. Check for three phase voltage, soft starter terminals 1, 2 and 3. With the control panel isolator OFF check wiring to compressor motor and compressor motor windings.



Due to vibration during transport the soft starter internal bypass contactor may be in a undefined state. If the following procedure is not followed this may result in the compressor momentarily starting when the unit power is first turned on.

IMPORTANT

During commissioning or if the soft start is replaced the following procedure MUST BE PERFORMED.

1. With the unit switch and unit switch disconnect set to OFF to isolate the unit, remove the fuses from the compressors fitted with a soft starter.
2. Turn ON the unit switch disconnect to turn on the unit supply and thus apply control circuit voltage to soft starter terminals A1 and A2.

3. Turn OFF the unit disconnect switch and refit the compressor fuses.

YCWL UNITS ONLY

Three Way Valve Signal

In some applications, on initial start, where the cooling tower liquid can be cold, the YCWL can trip on low pressure. To overcome this issue an output is provided which can be used by the customer to control a 3-way valve to by pass some of the condenser liquid flow (reduce the liquid flow into the condenser) to increase the YCWL's operating pressure.

Under the program key there are the following associated settings

PROGRAM	LOW LIMIT	HIGH LIMIT	DEFAULT
3-WAY VALVE RLT TEMP SETP (°C)	12.8	18.3	15.6
3-WAY VALVE PRESS DIFF SETP (Barg)	6.9	9.6	6.9
3-WAY VALVE VOLTAGE SETPOINT (Vdc)	4	7	5
3-WAY VALVE ON TIME (sec)	180	600	300

Operation

During the first six minutes of YCWL run time, with all the compressors in a system running, if the return condenser liquid temperature falls below the Programmed 3-Way valve Return Liquid Temperature Setpoint and the differential pressure between discharge and suction is less than the programmed 3-Way Valve Pressure Differential Setpoint, the 3-way valve output is set to the 3-Way Value Voltage Setpoint.

The customer should use this voltage to set the 3 way valve to reduce flow to the condenser.

Customer terminal block -XTBC1 terminal 52 and 53.

At the then end of the 3-Way Valve On Time, the 3-Way value output will fall to zero and the customers valve should operate as normal.

10 INPUTS / OUTPUTS

10.1 Digital Inputs

Note -ARB is only used on YLAA and YLAE units.

INPUT	-AMB	-ARB	DESCRIPTION	IDENT
	J13-1	-XP7-1	+30VDC	
1	J13-2	-XP7-2	UNIT SWITCH	-SOA
2	J13-3	-XP7-3	PULSE WIDTH MODULATED TEMPERATURE RESET or REMOTE UNLOAD STEP 2	PWM
3	J13-4	-XP7-4	REMOTE UNLOAD STEP 1	RU
4	J13-5	-XP7-5	REMOTE START STOP	RP
5	J13-6	-XP7-6	MODE SELECTION YLAA two speed fan unit fan speed inhibit. (CLOSED: Inhibit) YCWL Heatpump units (OPEN: cooling. CLOSED: Heating)	MS
6	J13-7	-XP7-7	NOT USED	NU
7	J13-8	-XP7-8	SYS 1 FAULT INPUT	=1-KCR
8	J13-9	-XP7-7	FLOW SWITCH	SF
9	J13-10	-XP7-9	SYS 2 FAULT INPUT	=2-KCR

10.2 Analogue Inputs

INPUT	-AMB	DESCRIPTION	IDENT
	J11-1,3,4,5,6,7	0V	
	J11-7,8,9,10	+5V	
1	J11-11	REMOTE TEMP RESET +SIGNAL	-ARTE
2	J11-6	REMOTE TEMP RESET -SIGNAL	-ARTE
3	J11-12	NOT USED	-R2
4	J11-13	YLAE TWO SPEED FAN, FULL SPEED INHIBIT	-ARB K22
5	J11-14	HYDRO KIT PUMP TRIP 1 (if fitted)	-ARB K24
6	J11-15	HYDRO KIT PUMP TRIP 2 (if fitted)	-ARB K23
	J6-1,2,3	0V	
	J6-4,5,6	+5V	
7	J6-7	LEAVING LIQUID TEMPERATURE COLD	-BLCT
8	J6-8	RETURN LIQUID TEMPERATURE COLD (if fitted)	-BECT
9	J6-9	AMBIENT TEMPERATURE (YLAA and YLAE units only)	-BAMB
	J7-1,2,3,4,7,9	0V	
	J7-5,6,8	+5V	
10	J7-10	SYS 1 SUCTION PRESSURE	=1-BSP
11	J7-11	SYS 1 DISCHARGE PRESSURE	=1-BDP
12	J7-12	NOT USED	NU
	J8-1,2,3	0V	
	J8-4,5,6	+5V	
13	J8-7	NOT USED	NU
14	J8-8	NOT USED	NU
15	J8-9	LEAVING LIQUID TEMPERATURE HOT (YCWL units only)	-BLHT
	J9-1,2,3,4,7,9	0V	
	J9-5,6,8	+5V	
16	J9-10	SYS 2 SUCTION PRESSURE	=2-BSP
17	J9-11	SYS 2 DISCHARGE PRESSURE	=2-BDP
18	J9-12	NOT USED	NU
	J10-1,2,3	0V	
	J10-4,5,6	+5V	
19	J10-7	NOT USED	NU
20	J10-8	NOT USED	NU
21	J10-9	RETURN LIQUID TEMPERATURE HOT (YCWL units, if fitted)	-BEHT

10.3 Digital Outputs

OUTPUT	-AMB	IDENT	DESCRIPTION	IDENT
	XTB7-1	115V VIA =ARD-K30		
1	XTB7-2	=AMB-K1	SYS 1 COMPRESSOR 1	=1-KM1
2	XTB7-3	=AMB-K2	SYS 1 LIQUID LINE SOLENOID VALVE	=1-YLLSV
3	XTB7-4	=AMB-K3	SYS 1 COMPRESSOR 2	=1-KM2
4	XTB7-5	=AMB-K4	SYS 1 COMPRESSOR 3	=1-KM3
	XTB7-6	115V		
5	XTB7-7	=AMB-K5	NOT USED	
5	XTB7-8	=AMB-K6	NOT USED	
6	XTB7-9	=AMB-K7	NOT USED	
7	XTB7-10	=AMB-K8	NOT USED	
	XTB10-1	115V VIA =ARD-K31		
8	XTB10-2	=AMB-K17	SYS 2 COMPRESSOR 1	=2-KM1
9	XTB10-3	=AMB-K18	SYS 2 LIQUID LINE SOLENOID VALVE	=2-LLSV
10	XTB10-4	=AMB-K19	SYS 2 COMPRESSOR 2	=2-KM2
11	XTB10-5	=AMB-K20	SYS 2 COMPRESSOR 3	=2-KM3
	XTB10-6	115V		
12	XTB10-7	=AMB-K21	NOT USED	
13	XTB10-8	=AMB-K22	NOT USED	
14	XTB10-9	=AMB-K23	NOT USED	
15	XTB10-10	=AMB-K24	NOT USED	
	XTB8-1	115V		
16	XTB8-2	=AMB-K9	NOT USED	
17	XTB8-3	=AMB-K10	SYS 1 FAULT	=1-KCR
18	XTB8-4	=AMB-K11	HYDRO KIT PUMP 2 (if fitted)	
19	XTB8-5	=AMB-K12	YLAA TWO SPEED FANS SYSTEM 1 FAST/SLOW	=1-KFS
20	XTB8-6/7	=AMB-K13	EXTERNAL EVAPORATOR PUMP or HYDRO KIT PUMP 1 (if fitted)	-XTBC2 23/34
21	XTB8-8/9	=AMB-K14	YLAA TWO SPEED FANS SYSTEM 2 FAST/SLOW	=2-KFS
22	XTB9-1/2	=AMB-K15	SYS 2 FAULT	=2-KCR

10.4 Analogue Output

OUTPUT	-AMB	DESCRIPTION
1	J15-3 (J15-7, 0V)	3-WAY VALVE OUTPUT

11 OPTIONAL PRINTER INSTALLATION

The microprocessor is capable of supplying a printout of chiller conditions or fault shutdown information at any given time. In addition, to the manually selected printouts the microprocessor will provide an automatic printout whenever a fault occurs. An explanation of the print function is given Section 5 under the Display/Print Keys.

If the RS232 (TB3) printer port does not work check the following. Press PROGRAM, DOWN ARROW, DOWN ARROW, DOWN ARROW, DOWN ARROW, ENTER keys in turn. Then repeatedly press the ENTER key and check the following settings: P2 PROTOCOL API, P2 BAUD RATE 1200, P2 PARITY NONE, P2 HW SELECT BIT RS-232. If necessary use the DOWN ARROW key to set the correct value, then press the ENTER key. Power down then power-up the unit.



The Printer option is not available if the Modbus feature is being used.

YORK offer a kit which includes a printer which has an internal Ni-cad battery, a roll of paper, a 'D' type connector, one metre lead and a charger. This is a compact low cost printer that is ideal for service work and data logging.

Paper is in the form of a compact roll and is easily handled compared to larger printers using wider business form style paper. The paper is 58 mm wide desktop calculator paper that can be easily and inexpensively purchased at most stationery stores.

11.1 Installation Limitations



The following limitations must be adhered to. Failure to do so may result in improper printer and/or chiller operation.

- Maximum cable length between the printer and the Microprocessor Board is 7.5 m. Twisted pair shielded cable is required (1 m with optional printer).
- Serial printer should be set for data bits = 8 parity = none and baud rate = 1200.
- The printer may be left connected to the microprocessor panel.

11.2 Parts

The following parts are required:

- Printer kit, YORK part number:

362L11330-002 UK
362L11330-003 EUROPE



The printer must be set up by customer as detailed using the operator guide supplied with printer.

- 58 mm wide desk top calculator paper.

One roll included in kit.
Extra roll part no. 025L01992-000

- Spare Ink Ribbon YORK part number:

025L01993-000

11.3 Assembly and Wiring

All components should be assembled and wired as shown in below. Strip the outer insulation back several centimetres and individual wires 10 mm to connect the cable at the microprocessor board (TB2). Do not connect the shield at the printer-end of the cable.

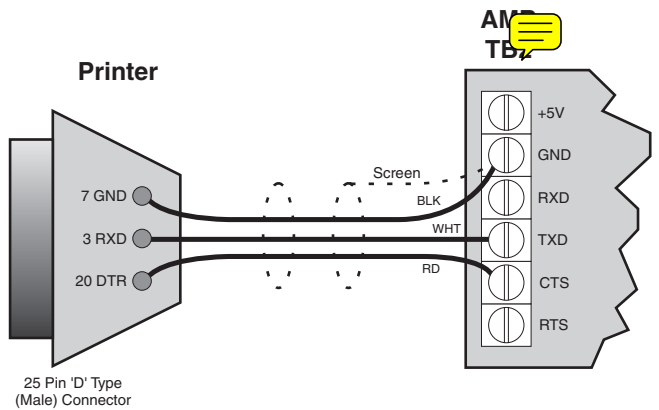

AMB TB3	Function	Printer
TXD	Serial data to printer	RXD
CTS	Busy signal from printer (high to accept data)	DTR
GND	Signal ground to printer	GND
White (WHT) Black (BLK) Red (RD)	Cable colours with York Supplied printer option	

11.4 Using Other Printers

Control codes vary from printer to printer. This may result in unusual formatting of printed data from many printers. In addition, 'handshaking' lines and 'handshaking' sequence will differ between printers.

This makes the equipment susceptible to operation problems or mis-wiring which may cause damage to the printer or the microprocessor board. YORK assumes no responsibility for assistance or damage in the use of non-specified printers.

11.5 Warranty

YORK assumes no warranty responsibility in the use of the printer. This includes damages to the printer and the microprocessor board or unit operation problems which may result.

11.6 Obtaining a Printout

A printout can be obtained by pressing the 'PRINT' key on the keypad and then pressing either the 'OPER DATA' key or 'HISTORY' key.

12 BAS/EMS TEMPERATURE RESET USING A VOLTAGE OR CURRENT SIGNAL



If the EMS-PWM feature has been activated, no message REMOTE TEMP RESET INPUT is visible under the OPTION key the following feature is disabled. Contact Johnson Controls York Product service if you require the following feature.

The chilled liquid setpoint can be reset Upwards from the manually entered setpoint by using a remote 0 - 10 Vdc or 2 - 10 Vdc or 0 - 20 ma or a 4 - 20 mA signal connected to terminal block -XTBC1 terminals A- and A+.

Whenever a reset is called for by the remote signal, the change may be viewed by pressing the Setpoints key twice. The new value will be displayed as 'REM C SP = XXX °C'. The analogue input is only read for a fixed interval. This is normally factory set to 5 minutes.

12.1 0-10 Vdc Remote Signal

Jumper JP on the I/O board must be set to 10 V.

To calculate the reset chilled liquid setpoint for values between 0 Vdc and 10 Vdc use the following formula:

Setpoint = Local Chilled Liquid Setpoint + °C Reset

$$^{\circ}\text{C Reset} = \frac{(\text{DC voltage signal}) \times \text{*Max Reset Value}}{10}$$

Example:

Local Chilled Liquid Setpoint = 6.4°C

*Max Reset Value = 10°C

Input Signal = 6 Vdc

$$^{\circ}\text{Reset} = \frac{(6 \text{ Vdc} \times 10.0 \text{ }^{\circ}\text{C})}{10} = 6.0 \text{ }^{\circ}\text{C Reset}$$

New Setpoint = 6.4 °C + 6.0 °C = 12.4 °C

12.2 2-10 Vdc Remote Signal

Jumper JP on the I/O board must be set to 10 V.

To calculate the reset chilled liquid setpoint for values between 2 Vdc and 10Vdc use the following formula:

Setpoint = Local Chilled Liquid Setpoint + °C Reset

$$^{\circ}\text{C Reset} = \frac{((\text{DC voltage signal} - 2) \times \text{*Max Reset Value})}{8}$$

Example:

Local Chilled Liquid Setpoint = 6.9 °C

*Max Reset Value = 10 °C

Input Signal = 4 Vdc

$$^{\circ}\text{C Reset} = \frac{((4\text{VDC} - 2) \times 10.0 \text{ }^{\circ}\text{C})}{8} = 2.5 \text{ }^{\circ}\text{C Reset}$$

New Setpoint = 6.9 °C + 2.5 °C = 9.4 °C

12.3 0-20 mA Remote Signal

Jumper JP on the I/O board must be set to 20 mA.

To calculate the chilled liquid setpoint for values between 0 mA and 20 mA use the following formula:

Setpoint = Local Chilled Liquid Setpoint + °C Reset

$$^{\circ}\text{C Reset} = \frac{(\text{mA signal} \times \text{*Max Reset Value})}{20}$$

Example:

Local Chilled Liquid Setpoint = 6.4 °C

*Max Reset Value = 5.0 °C

Input Signal = 10 mA

$$^{\circ}\text{C Reset} = \frac{(10 \text{ mA} \times 5.0 \text{ }^{\circ}\text{C})}{20} = 2.5 \text{ }^{\circ}\text{C Reset}$$

New Setpoint = 6.4 °C + 2.5 °C = 8.9 °C

12.4 4-20 mA Remote Signal

Jumper JP on the I/O board must be set to 20 mA.

To calculate the chilled liquid setpoint for values between 4 mA and 20 mA use the following formula:

$$\text{Setpoint} = \text{Local Chilled Liquid Setpoint} + \text{°C Reset}$$

$$\text{°C Reset} = \frac{((\text{mA signal} - 4) \times \text{*Max Reset Value})}{16}$$

Example:

Local Chilled Liquid Setpoint = 6.4 °C

*Max Reset Value = 6.0 °C

Input Signal = 8 mA

$$\text{°C Reset} = \frac{((8\text{mA} - 4\text{mA}) \times 6.0 \text{°C})}{16} = 1.5 \text{°C Reset}$$

$$\text{Setpoint} = 6.4 \text{°C} + 1.5 \text{°C} = 7.9 \text{°C}$$

* Max Reset Value is the 'Max EMS-PWM Remote Temp. Reset' setpoint value described in the programming section under Cooling Setpoints. Programmable values are from 1.11 °C to 11.11°C).

12.5 EMS-PWM Remote Temperature Reset



The EMS-PWM feature is not normally available. If the message REMOTE TEMP RESET INPUT (being the analogue input) is visible under the OPTION key even when set to DISABLED the EMS-PWM feature is disabled. Contact Johnson Controls York Product service if you require this feature. If enabled this feature will work even when the Option Local/Remote mode is set to Local. This input is not active if an ISN, Bacnet or Modbus is connected, Option Local/Remote is set to Remote and the ISN is not handing back control to the panel by sending 99 on ISN page 03.

The EMS-PWM remote temperature reset value at terminals 13 - 20 on -XTBC1, will reset the chilled liquid 'SETPOINT' based on the length of time the contacts remain closed. The maximum temperature reset allowed is achieved with a contact closure of 11 seconds. One second is the shortest time allowed and causes the chilled liquid 'SETPOINT' to revert back to the local programmed value.

The reset value is always added to the chilled liquid 'SETPOINT', meaning that this function never lowers the chilled liquid 'SETPOINT' below the locally programmed value, it can only reset to a higher value.

The microprocessor board must be refreshed between 30 seconds and 30 minutes. Any contact closure occurring sooner than 30 seconds will be ignored. If more than 30 minutes elapse before the next contact closure, the setpoint will revert back to the locally programmed value.

The new chilled liquid 'SETPOINT' is calculated:

$$\text{'SETPOINT'} = \text{chilled liquid 'SETPOINT'} + \text{'°RESET'}$$

$$\text{'°RESET'} = \frac{(\text{Contact Closure} - 1) \times (\text{*Max. Reset Value})}{10}$$

Example:

Local Chilled Liquid Setpoint = 6.1°C.

*Max Reset Value = 10.0°C

Contact Closure Time = 6 Seconds.

$$(6 \text{ sec} - 1) * (10.0\text{°C}/10) = 5.0\text{°C}$$

$$\text{Reset 'SETPOINT'} = 6.1\text{°C} + 5.0\text{°C} = 11.1\text{°C}$$

This can be viewed by pressing the 'SETPOINTS' key twice:

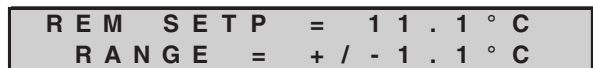

13 ISN CONTROL(York Talk -AMB Terminal Block TB1)

Note if communications cannot be established check that the panel has been set up for York Talk. Press the Program key, followed by four presses on the down arrow key, followed by the Enter key. The DE MODIFIER ADDRESS must be set to minus one. Use the Enter and down arrow keys to set the value. Repeatedly press the Enter key until the REAL TIME ERROR is displayed. Reset it if it is not zero. Turn the power to the panel off then turn back on. Note on power up the second line of the display should read INITIALIZING not INITIALIZING BACNET.

13.1 Received Data (Control Data)

The unit receives 8 data values from the ISN. The first 4 (ISN Page P03 to P06, 2 unused) are analog values and the last 4 (ISN Page P07 to P10, 2 unused) are digital values. These 4 data values are used as control parameters when in REMOTE mode. When the unit is in LOCAL mode, these 4 values are ignored. If the unit receives no valid ISN transmission for 5 minutes it will revert back to local control values. The table below lists the 4 used control parameters. These values are found under feature 54 on the ISN.

ISN PAGE	CONTROL DATA
P03	CHILLED SETPOINT (99 = UNIT SETPOINT)
P04	LOAD LIMIT STAGE (0, 1, 2)
P05	HOT SETPOINT (999 = UNIT SETPOINT)
P06	0 = Chiller, 1 = Heatpump, 999 = Hand back to panel
P07	START/STOP COMMAND
P10	HISTORY BUFFER REQUEST

13.2 Transmitted Data

After receiving a valid transmission from the ISN, the unit will transmit either operational data or history buffer data depending on the status of the 'History Buffer Request' (ISN Page 10). Data must be transmitted for every ISN Page under feature 54. If there is no value to be sent to a particular page, a zero will be sent.

The tables below show the data values and Page listings for the unit.

ISN Transmitted Data

ISN PAGE	TYPE	DATA
P11	ANALOG	LEAVING CHILLED LIQUID TEMP.
P12	ANALOG	RETURN CHILLED LIQUID TEMP. (YLAA/YCWL only)
P13	ANALOG	LEAVING HOT LIQUID TEMP. (YCWL only)
P14	ANALOG	RETURN HOT LIQUID TEMP. (YCWL only)
P16	ANALOG	AMBIENT AIR TEMP. (YLAA/YLAE only)
P18	ANALOG	SYS 1 RUN TIME (SECONDS)
P19	ANALOG	SYS 1 SUCTION PRESSURE
P20	ANALOG	SYS 1 DISCHARGE PRESSURE
P24	ANALOG	SYS 1 ANYI-RECYCLE TIMER
P25	ANALOG	ANTI-COINCIDENT TIMER
P27	ANALOG	SYS 2 RUN TIME (SECONDS)
P28	ANALOG	SYS 2 SUCTION PRESSURE
P29	ANALOG	SYS 2 DISCHARGE PRESSURE
P33	ANALOG	SYS 2 ANTI-RECYCLE TIMER
P35	ANALOG	NUMBER OF COMPRESSORS
P36	DIGITAL	SYS 1 ALARM
P37	DIGITAL	SYS 2 ALARM
P38	DIGITAL	EVAPORATOR HEATER (YLAA/YLAE only)
P39	DIGITAL	EVAPORATOR PUMP STATUS
P40	DIGITAL	SYS 1 COMP 1 RUN
P41	DIGITAL	SYS 2 COMP 1 RUN
P42	DIGITAL	SYS 1 LIQUID LINE SOLENOID VALVE
P44	DIGITAL	SYS 1 COMP 2 RUN
P45	DIGITAL	SYS 2 COMP 2 RUN
P46	DIGITAL	SYS 2 LIQUID LINE SOLENOID VALVE
P47	DIGITAL	LEAD SYSTEM (0=SYS 1, 1 SYS 2)
P48	DIGITAL	SYS 1 COMP 3 RUN
P49	DIGITAL	SYS 2 COMP 3 RUN
P50	DIGITAL	CHILLED LIQUID TYPE (0=WATER, 1=GLYCOL)
P52	DIGITAL	LOCAL / REMOTE CONTROL MODE (0=LOCAL, 1=REMOTE)
P53	DIGITAL	UNITS (0=IMPERIAL, 1=SI)
P54	DIGITAL	LEAD/LAG CONTROL MODE (0=MANUAL, 1=AUTO)
P56	CODED	*SYS 1 OPERATIONAL CODE
P57	CODED	*SYS 1 FAULT CODE
P58	CODED	*SYS 2 OPERATIONAL CODE
P59	CODED	*SYS 2 FAULT CODE
P61	CODED	**SYS 1 FAN STAGES
P63	CODED	**SYS 2 FAN STAGES
P66	ANALOG	ANTI-RECYCLE TIME (PROGRAMMED)
P67	ANALOG	LEAVING CHILLED LIQUID TEMP CUTOUT
P68	ANALOG	LOW AMBIENT TEMP CUTOUT
P70	ANALOG	LOW SUCTION PRESS CUTOUT
P71	ANALOG	HIGH DISCHARGE PRESS CUTOUT
P72	ANALOG	COOLING SETPOINT
P73	ANALOG	COOLING RANGE
P74	ANALOG	SETPOINT HEATING (YCWL Heatpump Mode)
P75	ANALOG	HEATING RANGE (YCWL Heatpump Mode)

* See ISN Operational and Fault code table below.

** For interpretation of fan stages see tables in sections 2.8.1 and 2.8.2.

ISN Operational and Fault Codes

P56/58	OPERATIONAL CODE
0	NO ABNORMAL CONDITION
1	UNIT SWITCH OFF
2	SYSTEM SWITCH OFF
3	LOCK-OUT
4	UNIT FAULT
5	SYSTEM FAULT
6	REMOTE SHUTDOWN
7	DAILY SCHEDULE SHUTDOWN
8	NO RUN PERMISSIVE
9	NO COOL LOAD
10	ANTI-COINCIDENCE TIMER ACTIVE
11	ANTI-RECYCLE TIMER ACTIVE
12	MANUAL OVERRIDE
13	SUCTION LIMITING
14	DISCHARGE LIMITING
16	LOAD LIMITING
17	COMPRESSOR(S) RUNNING
P57/59	FAULT CODE
0	NO FAULT
1	VAC UNDERVOLTAGE
2	LOW AMBIENT TEMPERATURE
4	LOW LEAVING CHILLED LIQUID TEMP
5	HIGH DISCHARGE PRESSURE
7	LOW SUCTION PRESSURE
18	MP/HPCO FAULT
26	MP/HPCO INHIBIT
27	HK - UNIT FAULT PUMP TRIP (BOTH TRIPPED ON 2 PUMP OPTION)
28	HK - UNIT FAULT PUMP FAIL MAKE FLOW

HK = Hydro Kit Option

14 BACnet and Modbus (~~AMB Board Terminal Block TB1~~)

Data can be read and in some cases modified using a serial communication BACnet or Modbus network connection. This information allows communications of unit operating parameters and external control changes to setpoint, load limiting, and start/stop commands.

14.1 BACnet and Modbus Data Communication

In some cases, BACnet parameters may need to be modified [port P1 (RS485 TB1) and or Modbus port P2 (RS485 TB2, P2 HW select bit set to RS-485)]. If communications cannot be established check that the panel has been setting up for the correct communication protocol. Setting the DE MODIFIER ADDRESS to minus one, sets the RS485 port TB1 up for York Talk. For protocols other than York Talk set the correct parameters then turn the power to the panel off then back on.



For Bacnet P1 Protocol must be set to Bacnet and for Modbus P2 Protocol must be set to MODBUS SRV.

On power up the second line of the display should read INITIALIZING BACNET. Modification is accomplished by pressing the PROGRAM, DOWN ARROW, DOWN ARROW, DOWN ARROW, DOWN ARROW, and ENTER keys in sequence. The list below shows the displays for the values that may be modified:

DE MODIFIER ADDRESS XXXXX
DE MODIFIER OFFSET XX
P1 PROTOCOL XXXXXX
P1 MANUAL MAC ADDRESS XXX
P1 BAUD RATE XXXXX
P1 PARITY XXXXX
P1 STOP BITS X
P2 PROTOCOL XXXXXXXXXX
P2 MANUAL MAC ADDRESS XXX
P2 BAUD RATE XXXXX
P2 PARITY XXXXX
P2 STOP BITS X
P2 HW SELECT BIT XXXXXX XXXXXX = RS-232 or RS-485
REAL TIME ERROR ## RESET 1 = YES, 0 = NO 0

IPU II Port Settings

With unit switch set to OFF press PROGRAM, DOWN ARROW, DOWN ARROW, DOWN ARROW, DOWN ARROW, ENTER keys in turn and then set the following:

	YORK TALK TB1 (PORT 1)	BACNET TB1 (PORT 1)	MODBUS TB2 (PORT 2)
DE MODIFIER ADDRESS	-1	AS REQUIRED NOT -1	DONT CARE NOT -1
DE MODIFIER OFFSET	DONT CARE	AS REQUIRED	DONT CARE
P1 PROTOCOL	DONT CARE	BACNET	DONT CARE
P1 MANUAL MAC ADDRESS	DONT CARE	AS REQUIRED	DONT CARE
P1 BAUD RATE	DONT CARE	AS REQUIRED	DONT CARE
P1 PARITY	DONT CARE	AS REQUIRED	DONT CARE
P1 STOP BITS	DONT CARE	AS REQUIRED	DONT CARE
P2 PROTOCOL	DONT CARE	DONT CARE	MODBUS SVR
P2 MANUAL MAC ADDRESS	DONT CARE	DONT CARE	AS REQUIRED
P2 BAUD RATE	DONT CARE	DONT CARE	AS REQUIRED
P2 PARITY	DONT CARE	DONT CARE	AS REQUIRED
P2 STOP BITS	DONT CARE	DONT CARE	AS REQUIRED
P2 HW SELECT	DONT CARE	DONT CARE	RS485

Reset any real time errors

After making settings cycle power. Check the second line of the display on power up. For York Talk Bacnet (modbus) will NOT be initialized, for Bacnet (Modbus), Bacnet will be initialized.

The table below shows the minimum, maximum and default values:

DESCRIPTION	MINIMUM	MAXIMUM	DEFAULT
De Modifier Address	-1	41943	-1
De Modifier Offset	-1	99	-1
P1 Protocol	BACNET	API	BACNET
	BACNET, API Selectable		
P1 Manual Mac Address	0	127	1
P1 Baud Rate	1200	76800	4800
	1200, 4800, 9600, 19200, 38400, 57600, 76800 AUTO Selectable		
P1 Parity	None	Ignore	None
	None, Even, Odd, Ignore Selectable		
P1 Stop Bits	1	2	1
P2 Protocol	Terminal	Modbus Client	API
	TERMINAL, UNAVAIL, MODBUS IO, MODBUS SERVER, API, MODBUS CLIENT Selectable		
P2 Manual Mac Address	0	127	1
P2 Baud Rate	1200	76800	1200
	1200, 4800, 9600, 19200, 38400, 57600, 76800 Selectable		
P2 Parity	None	Ignore	None
	None, Even, Odd, Ignore Selectable		
P2 Stop Bits	1	2	1
P2 HW Select Bit	RS232	RS485	RS232
Reset Real Time Error	NO	YES	None

The table below details the real time error numbers and a description of each error:

ERROR NUMBER (##)	DESCRIPTION
0	ALL OK
1	DATUM TYPE OK TEST FAILED
2	ENGLISH TEXT TOO LONG
3	FLOATING POINT EXCEPTION
4	GET PACKET FAILED
5	GET TYPE FAILED
6	INVALID UNIT CONVERSION
7	INVALID HARDWARE SELECTION
8	REAL TIME FAULT
9	SPANISH TEXT TOO LONG
10	THREAD EXITED
11	THREAD FAILED
12	THREAD STALLED
13	IO BOARD RESET
14	BRAM INVALID
15	BACNET SETUP FAILED

Unit data that can be read and modified using specific Modbus Register Addresses; and the data associated with the addresses, is outlined in the following description:

SERIAL COMMUNICATION ANALOG VALUE DATA

This data can be read and modified using a BACnet or Modbus network connection. The Modbus Register Address for these points is 1025 + AV #.

AV	BACNET NAME	ANALOG VALUE DESCRIPTION
1	REM_SETP	SETPOINT COOLING SETPOINT WATER 4.4 °C TO 21.1°C GLYCOL -7.2°C TO 21.1°C LOW TEMP GLYCOL -13.3°C TO 21.1°C 37.2 = Handback to panel when under options display units are set to SI or 99 when set to imperial
2	SP_REM_SP_S1	NOT USED
3	LOAD_LIMIT LOAD LIMIT STAGE	(0, 1, 2)
4	REM_CR COOLING RANGE	NOT USED
5	SP_REM_SP_S2 SYS 2	NOT USED
6	REM_SP_HEAT	HEATING SETPOINT 30 °C - 52°C 537.2 = Handback to panel when under options display units are set to SI or 999 when set to imperial
7	HP_MODE	MODE (0 = PANEL, 1 = COOLING, 2 = HEATING) (YCWL Heatpump only)

SERIAL COMMUNICATION BINARY VALUE DATA

This data can be read and modified using a BACnet or Modbus network connection. The Modbus Register Address for these points is 1537 + BV #.

BV	BACNET	NAME BINARY VALUE DESCRIPTION
1	START_STOP	START / STOP COMMAND

SERIAL COMMUNICATION BINARY INPUT DATA

This data can be read using a BACnet or Modbus network connection and can NOT be modified using this connection. The Modbus Register Address for these points is 1281 + BI #.

BI	BACnet NAME	BINARY INPUT DESCRIPTION
1	S1_ALARM	SYS 1 ALARM
2	S2_ALARM	SYS 2 ALARM
3	EVAP_HTR	EVAPORATOR HEATER (YLAA/YLAE only)
4	EVAP_PUMP	EVAPORATOR PUMP STATUS
5	S1_C1_RUN	SYS 1 COMP 1 RUN
6	S2_C1_RUN	SYS 2 COMP 1 RUN
7	S1_LLSV	SYS 1 LIQUID LINE SOLENOID VALVE
8	S1_MODE_SV	NOT USED
9	S1_HGBV	NOT USED
10	S1_BHS	NOT USED
11	S1_C2_RUN	SYS 1 COMP 2 RUN
12	S2_C2_RUN	SYS 2 COMP 2 RUN
13	S2_LLSV Sys 2	SYS 2 LIQUID LINE SOLENOID VALVE
14	S2_MODE_SV	NOT USED
15	LEAD_SYS	LEAD SYSTEM (0 = SYS 1, 1 = SYS 2)
16	S1_C3_RUN	SYS 1 COMP 3 RUN
17	S2_C3_RUN	SYS 2 COMP 3 RUN
18	CH_LIQ_TYPE	CHILLED LIQUID TYPE (0=WATER, 1=GLYCOL)
19	AMB_MODE	NOT USED
20	CNTL_MODE	LOCAL/REMOTE CONTROL MODE (0=LOCAL, 1=REMOTE)
21	DATA_UNIT	UNITS (0=IMPERIAL, 1=SI)
22	AUTO_LL	LEAD/LAG CONTROL MODE (0=MANUAL, 1=AUTO)
23	S2_HGSV	NOT USED

SERIAL COMMUNICATION ANALOG INPUT DATA

This data can be read using a BACnet or Modbus network connection and can NOT be modified using this connection. The Modbus Register Address for these points is 513 + AI #.

AI	BACNET NAME	ANALOG INPUT DESCRIPTION
1	LCHLT	LEAVING CHILLED LIQUID TEMP
2	RCHLT	RETURN CHILLED LIQUID TEMP (YLAA/YCWL only)
3	DAT	NOT USED
4	S1_SUCT_TEMP	NOT USED
5	OAT	AMBIENT AIR TEMPERATURE (YLAA and YLAE units only)
6	S1_SUCT_SH	NOT USED
7	S1_RUN_TIME	SYS 1 RUN TIME (SECONDS)
8	S1_SUCT_PR	SYS 1 SUCTION PRESSURE
9	S1_DSCH_PR	SYS 1 DISCHARGE PRESSURE
10	S1_CIR_TEMP	NOT USED
11	S1_DEF_TEMP	NOT USED
12	S1_EEV_OUT	NOT USED
13	S1_AR_TIMER	SYS 1 ANTI-RECYCLE TIMER
14	AC_TIMER	ANTI-COINCIDENT TIMER
15	S2_SUCT_TEMP	NOT USED
16	S2_RUN_TIME	SYS 2 RUN TIME (SECONDS)
17	S2_SUCT_PR	SYS 2 SUCTION PRESSURE
18	S2_DSCH_PR	SYS 2 DISCHARGE PRESSURE
19	S2_CIR_TEMP	NOT USED
20	S2_DEF_TEMP	NOT USED
21	S2_SUCT_SH	NOT USED
22	S2_AR_TIMER	SYS 2 ANTI-RECYCLE TIMER
23	S2_EEV_OUT	NOT USED
24	NUM_COMPS	NUMBER OF COMPRESSORS
25	S1_OP_CODE	*SYS 1 OPERATIONAL CODE
26	S1_FLT_CODE	*SYS 1 FAULT CODE
27	S2_OP_CODE	*SYS 2 OPERATIONAL CODE
28	S2_FLT_CODE	*SYS 2 FAULT CODE
29	S1_DBG_CODE	NOT USED
30	S1_FAN_STAGE	**SYS 1 FAN STAGES (YLAA/YLAE only)
31	S2_DBG_CODE	NOT USED
32	S2_FAN_STAGE	**SYS 1 FAN STAGES (YLAA/YLAE only)
33	CONTROL_MODE	UNIT CONTROL MODE (5=COOLING, 6=HEATING)
34	AR_TIME	ANTI-RECYCLE TIME (PROGRAMMED)
35	LCHLT_CUT	LEAVING CHILLED LIQUID TEMP CUTOUT
36	LOW_AMB_CUT	LOW AMBIENT TEMPERATURE CUTOUT
37	SUCT_P_CO_HT	NOT USED
38	L_SUCT_P_CO	LOW SUCTION PRESSURE CUTOUT
39	H_DSCH_P_CO	HIGH DISCHARGE PRESSURE CUTOUT
40	COOL_SETP Setpoint	COOLING SETPOINT
41	SP_SETP_S1	NOT USED
42	CONTROL_RG	COOLING RANGE
43	SP_CTL_RG_S1	NOT USED
44	SP_SETP_S2	NOT USED
45	HEAT_SETP	HEATING SETPOINT (YCWL only)
46	SP_CTL_RG_S2	NOT USED
47	HEAT_RANGE	HEATING RANGE (YCWL only)
48	S1_DSCH_TEMP	NOT USED
49	S1_DSCH_SH	NOT USED
50	S2_DSCH_TEMP	NOT USED
51	S2_DSCH_SH	NOT USED
52	LEAVING_HOT	LEAVING LIQUID HOT TEMPERATURE (YCWL Units only)
53	RETURN_HOT	RETURN LIQUID HOT TEMPERATURE (YCWL Units only)

* See ISN Operational and Fault code table.

** For interpretation of fan stages see tables in sections 2.8.1 and 2.8.2.

15 HEATPUMP OPTION

```
Y C W L H E A T P U M P   U N I T
```

This option is factory set and can be confirmed by the above message under the 'OPTION'

With the heatpump option the unit can operate as a standard chiller or as a heatpump. The mode selection can be made at the control panel or remotely by a voltage free contact or a signal from a remote ISN controller Bacnet or Modbus.

15.1 Heatpump Mode Selection

If under the OPTION key the REMOTE / LOCAL mode is set to LOCAL the mode of operation can also be set under the OPTION key as follows.

To change the mode of the unit press the 'OPTION' key and then repeatedly press the 'ENTER/ADV' key until the mode is displayed. The mode is changed using the 'UP ARROW' and 'DOWN ARROW' keys. After the mode is changed the 'ENTER/ADV' key must be pressed to enter the setting into memory.

```
Y C W L   M O D E   S E L E C T E D
          C H I L L E R
```

OR

```
Y C W L   M O D E   S E L E C T E D
          H E A T P U M P
```

Selecting 'CHILLER' will mean that the operation of the unit is described in the other sections of this manual.

Selecting 'HEATPUMP' means that primary capacity control of the unit is under leaving hot liquid control with a secondary capacity control related to leaving cold liquid temperature. The remaining operation of the unit is as describe in the other sections of the manual.

If under the OPTION key REMOTE/LOCAL mode is set to REMOTE the mode is determined either by a voltage free contact connected to -XTBC1 terminals 13 and 50, closed for HeatPump operation or by a signal from a remote ISN controller, Bacnet or Modbus.

In both remote and local modes the operating mode can be viewed under the OPTION key. The messages are:

```
Y C W L   O P E R A T I N G   M O D E
          C H I L L E R
```

OR

```
Y C W L   O P E R A T I N G   M O D E
          H E A T P U M P
```

These messages are not updated dynamically, exit and re-enter the message to display any changes.

15.2 OPER DATA Key

```
L L T H   =   4 8 . 0 ° C
R L T H   =   4 2 . 0 ° C
```

Pressing the 'OPER DATA' key followed by the 'DOWN ARROW' key displays the Leaving Liquid Temperature Hot (LLTH) and the Return Liquid Temperature Hot (RLTH) when the optional temperature sensors are fitted.

15.3 SETPOINTS Key

When CHILLER MODE is selected the following setpoint displays are as for a standard chiller units and the Hot setpoint is not displayed

When HEATPUMP MODE is selected the cold leaving liquid temperature 'SETPOINT' and 'RANGE' can be viewed or programmed by pressing the 'SETPOINTS' key. After pressing the key the 'SETPOINT' and 'RANGE' entry message is displayed:

```
C S E T P   =   6 . 0 ° C
R A N G E   =   + / - 1 . 1 ° C
```

Refer to Section 7 for details of programming.

Pressing the 'SETPOINTS' key a second time will display the hot leaving liquid temperature 'SETPOINT' and 'RANGE' entry message:

```
H S E T P   =   5 0 . 0 ° C
R A N G E   =   + / - 1 . 5 ° C
```

The hot leaving liquid temperature 'SETPOINT' can be set in the range 30 to 52°C. The hot leaving liquid temperature 'RANGE' can be set between 0.5 to 5°C. Refer to Section 7 for details of programming.

Pressing the 'SETPOINTS' key a third time will display the remote 'SETPOINT' and 'RANGE'. These values apply to the H SETP not the C SETP set point. Any reset signals set the actual H SETP DOWN by the offset figure.

```
R E M   S E T P   =   4 2 . 0 ° C
R A N G E   =   + / - 1 . 5 ° C
```

15.4 Leaving Liquid Temperature Control

Leaving liquid control is based on Hot leaving liquid temperature against a Hot Leaving Liquid Temperature Set Point and Range (Heating) to determine unit loading. Load time is 60 seconds below the heating range. Unload time is 30 seconds above heating range up to 0.28°C above heating range. Between 0.28°C and 0.83°C above heating range unload time is 15 seconds. Above heating range plus 0.83°C unload time is 10 seconds.

The Cold Leaving Liquid Temperature Set Point and Range (cooling) are used to ensure that whilst the capacity step of the systems/compressors is set to meet the heating demand too low a cold liquid temperature will first prevent further loading, leaving liquid cold temperature in cooling range, and if necessary unload the systems/compressors, if leaving liquid cold temperature is below cooling range.

The change in unload timing as error increases still applies as described in the standard chiller section of the manual. TEMP ERROR in heatpump represents Leaving Liquid Temperature Hot error not Leaving Liquid Temperature cold error.

The existing programmed RATE CONTROL TEMP and RATE SENSITIVITY are common to both cooling and heatpump modes. There are two rate of change displayed one for the COLD liquid, one for the HOT liquid under oper data key.

TEMP RATE COLD	7 . 6
HOT =	3 . 6 ° C / MIN

The setpoint adjust feature (as described in Section 2) works as in the cooling mode but the heating setpoint low limit is lowered by up 10°C to a minimum of 25°C. Any adjustment value in excess of the value taking the Setpoint Low Limit to 25°C is added to the Setpoint High Limit.

15.5 BAS/EMS Temperature Reset - Voltage / Current Signal

If the EMS-PWM feature has been activated, no message REMOTE TEMP RESET INPUT is visible under the OPTION key and the following feature is disabled. Contact Johnson Controls York Product service if you require the following feature.

In the heating mode the hot liquid setpoint can be reset downwards from the manually entered setpoint by using a remote 0 - 10 Vdc or 2 - 10 Vdc or 0 - 20 ma or a 4 - 20 mA signal connected to terminal block -XTBC1 terminals A- and A+.

Whenever a reset is called for by the remote signal, the change may be viewed by pressing the 'SETPOINTS' key four times. The new value will be displayed as 'REM H SP = XXX °C'. The analogue input is only read for a fixed interval. This is normally factory set to 5 minutes.

15.5.1 0-10 Vdc Remote Signal

Jumper JP on the I/O board must be set to 10 V.

To calculate the reset hot liquid setpoint for values between 0 Vdc and 10 Vdc use the following formula:

Setpoint = Local Hot Liquid Setpoint - °C Reset

$$^{\circ}\text{C Reset} = \frac{(\text{DC voltage signal}) \times \text{*Max Reset Value}}{10}$$

Example:

Local Hot Liquid Setpoint = 50.0°C

*Max Reset Value = 10°C

Input Signal = 6 Vdc

$$^{\circ}\text{C Reset} = \frac{(6 \text{ Vdc} \times 10.0 \text{ }^{\circ}\text{C})}{10} = 6.0 \text{ }^{\circ}\text{C Reset}$$

New Setpoint = 50.0 °C - 6.0 °C = 44.0 °C

15.5.2 2-10 Vdc Remote Signal

Jumper JP on the I/O board must be set to 10 V.

To calculate the reset hot liquid setpoint for values between 2 Vdc and 10Vdc use the following formula:

Setpoint = Local Hot Liquid Setpoint - °C Reset

$$^{\circ}\text{C Reset} = \frac{((\text{DC voltage signal} - 2) \times \text{*Max Reset Value})}{8}$$

Example:

Local Hot Liquid Setpoint = 45.0 °C

*Max Reset Value = 10 °C

Input Signal = 6 Vdc

$$^{\circ}\text{C Reset} = \frac{((6 \text{ Vdc} - 2) \times 10.0 \text{ }^{\circ}\text{C})}{8} = 5.0 \text{ }^{\circ}\text{C Reset}$$

New Setpoint = 45.0 °C - 5.0 °C = 40.0 °C

15.5.3 0-20 mA Remote Signal

Jumper JP on the I/O board must be set to 20 mA.

To calculate the hot liquid setpoint for values between 0 mA and 20 mA use the following formula:

Setpoint = Local hot Liquid Setpoint - °C Reset

$$^{\circ}\text{C Reset} = \frac{(\text{mA signal} \times \text{*Max Reset Value})}{20}$$

Example:

Local Hot Liquid Setpoint = 50.0 °C

*Max Reset Value = 5.0 °C

Input Signal = 10 mA

$$^{\circ}\text{C Reset} = \frac{(10 \text{ mA} \times 5.0 \text{ }^{\circ}\text{C})}{20} = 2.5 \text{ }^{\circ}\text{C Reset}$$

$$\text{New Setpoint} = 50.0 \text{ }^{\circ}\text{C} - 2.5 \text{ }^{\circ}\text{C} = 47.5 \text{ }^{\circ}\text{C}$$

15.5.4 4-20 mA Remote Signal

Jumper JP on the I/O board must be set to 20 mA.

To calculate the hot liquid setpoint for values between 4 mA and 20 mA use the following formula:

$$\text{Setpoint} = \text{Local hot Liquid Setpoint} - ^{\circ}\text{C Reset}$$

$$^{\circ}\text{C Reset} = \frac{((\text{mA signal} - 4) \times \text{*Max Reset Value})}{16}$$

Example:

Local Hot Liquid Setpoint = 45.0 °C

*Max Reset Value = 5.0 °C

Input Signal = 12 mA

$$^{\circ}\text{C Reset} = \frac{((12 \text{ mA} - 4 \text{ mA}) \times 5.0 \text{ }^{\circ}\text{C})}{16} = 2.5 \text{ }^{\circ}\text{C Reset}$$

$$\text{Setpoint} = 45.0 \text{ }^{\circ}\text{C} - 2.5 \text{ }^{\circ}\text{C} = 42.5 \text{ }^{\circ}\text{C}$$

* Max Reset Value is the 'Max EMS-PWM Remote Temp. Reset' setpoint value described in the programming section under Cooling Setpoints. Programmable values are from 1.11 °C to 11.11°C).

15.6 EMS-PWM Remote Temperature Reset

The EMS-PWM feature is not normally available. If the message REMOTE TEMP RESET INPUT is visible under the OPTION key even when set to DISABLED the EMS-PWM feature is disabled. Contact Johnson Controls York Product service if you require this feature. If enabled this feature will work even when the Option Local/Remote mode is set to Local. This input is not active if an ISN, Bacnet or Modbus is connected, Option Local/Remote is set to Remote and the ISN is not handing back control to the panel by sending 99 on ISN page 05.

The EMS-PWM remote temperature reset value at terminals 13 - 20 on -XTBC1, will reset the hot liquid 'SETPOINT' based on the length of time the contacts remain closed. The maximum temperature reset allowed is achieved with a contact closure of 11 seconds. One second is the shortest time allowed and causes the hot liquid 'SETPOINT' to revert back to the local programmed value.

The reset value is always taken away from to the hot liquid 'SETPOINT', meaning that this function never raises the hot liquid 'SETPOINT' above the locally programmed value, it can only reset to a lower value.

The microprocessor board must be refreshed between 30 seconds and 30 minutes. Any contact closure occurring sooner than 30 seconds will be ignored. If more than 30 minutes elapse before the next contact closure, the setpoint will revert back to the locally programmed value.

The new hot liquid 'SETPOINT' is calculated:

$$\text{'SETPOINT'} = \text{hot liquid 'SETPOINT'} - ^{\circ}\text{RESET'}$$

$$^{\circ}\text{RESET} = \frac{(\text{Contact Closure} - 1) \times (\text{*Max. Reset Value})}{10}$$

Example:

Local hot Liquid Setpoint = 50.0°C.

*Max Reset Value = 10.0°C

Contact Closure Time = 6 Seconds.

$$(6 \text{ sec} - 1) \times (10.0^{\circ}\text{C}/10) = 5.0^{\circ}\text{C}$$

$$\text{Reset 'SETPOINT'} = 50.0^{\circ}\text{C} - 5.0^{\circ}\text{C} = 45^{\circ}\text{C}$$

This can be viewed by pressing the 'SETPOINTS' key three times.



www.johnsoncontrols.com